

THIS DOCUMENT MUST NOT BE COPIED WITHOUT  
 OUR WRITTEN PERMISSION, AND THE CONTENTS  
 THEREOF MUST NOT BE IMPARTED TO A THIRD  
 PARTY NOR BE USED FOR ANY UNAUTHORIZED  
 PURPOSE. CONTRAVENTION WILL BE PROSECUTED.

REVISIONS			
REV.	DESCRIPTION	DATE	SIGNATURE
A		2019-07-23	JA

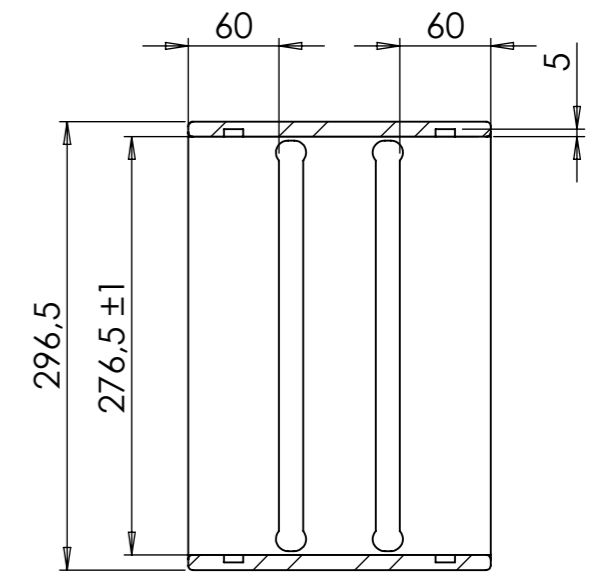

SECTION A-A

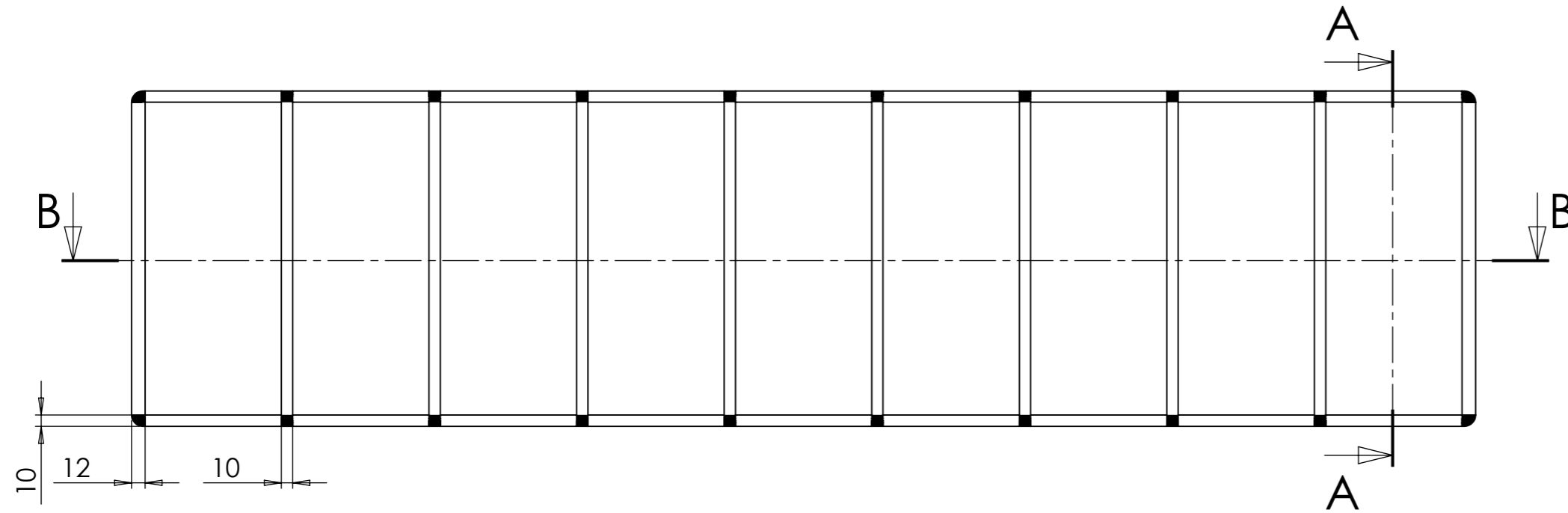
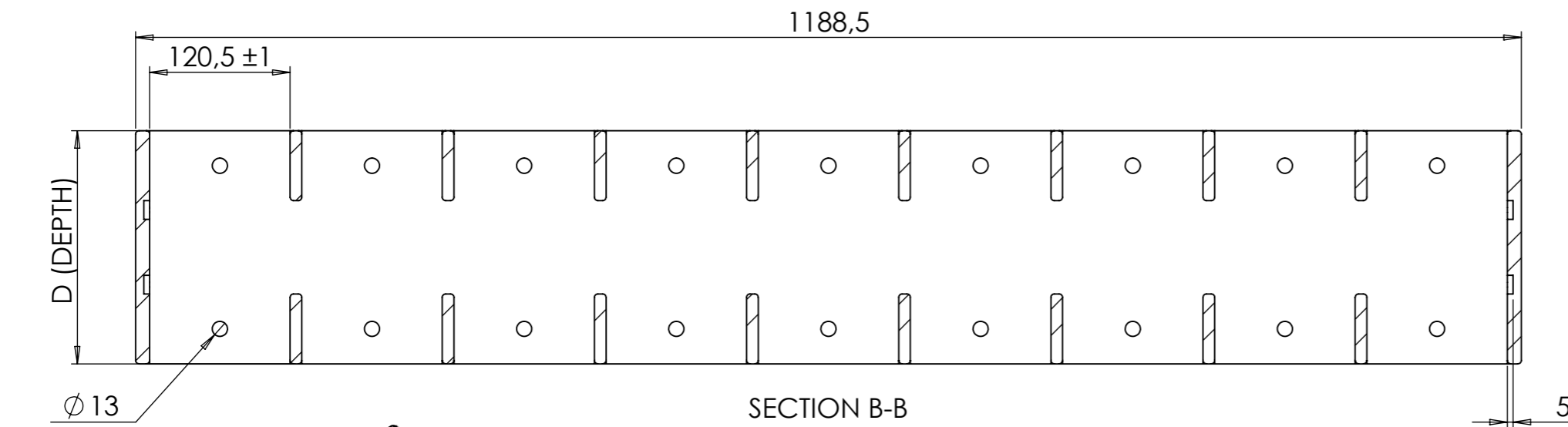

SECTION B-B

FRAME TYPE	D (DEPTH)
TYPE 1	200
TYPE 2	300

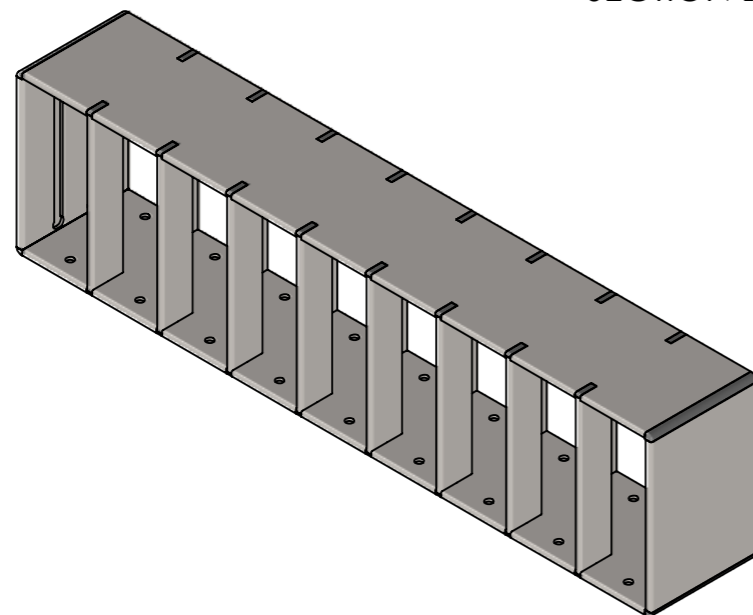

Ritad Drawn	Kontr. Check	Granskad Reviewed	Godkänd Approved	Tolerans där ej annat anges Tolerance unless otherwise not stated. ISO 13920-BF	Smst. nr. Assembly drawing no.	Ersätter Replaces	E
JA	JA	JF	BJ	Ytjämnhet där ej annat anges. Surface finish otherwise not stated.	Material	Ersatt av Replaced of	Vikt Weight
190719	190723	190809	190812	RGS-BTB-8x9 INFORMATION DRAWING		Alla mått och uppgifter avser färdig produkt om ej annat anges All measures and other information refer to finished products unless otherwise not stated.	
						Kund ordernr. Customer order no	
						1190287	A