

THIS DOCUMENT MUST NOT BE COPIED WITHOUT
 OUR WRITTEN PERMISSION, AND THE CONTENTS
 THEREOF MUST NOT BE IMPARTED TO A THIRD
 PARTY NOR BE USED FOR ANY UNAUTHORIZED
 PURPOSE. CONTRAVENTION WILL BE PROSECUTED.

REVISIONS			
REV.	DESCRIPTION	DATE	SIGNATURE
A		2019-12-04	JA

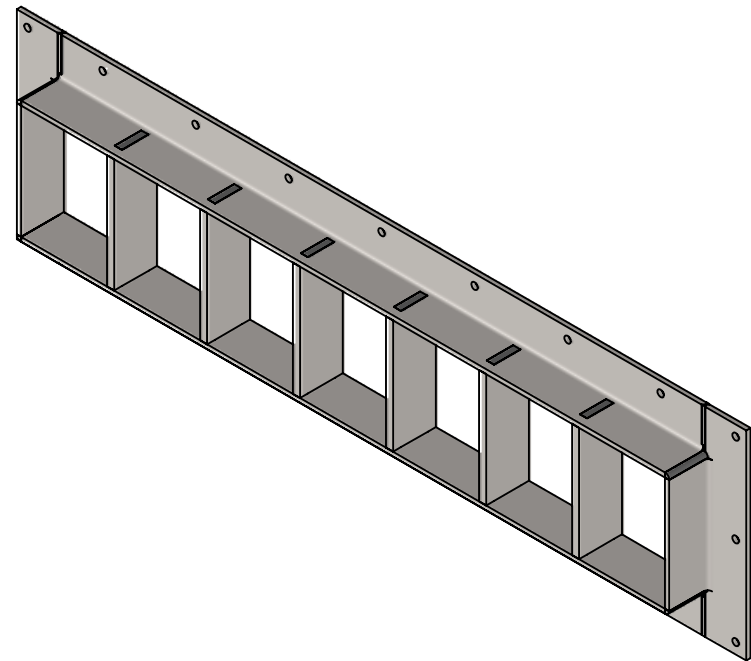
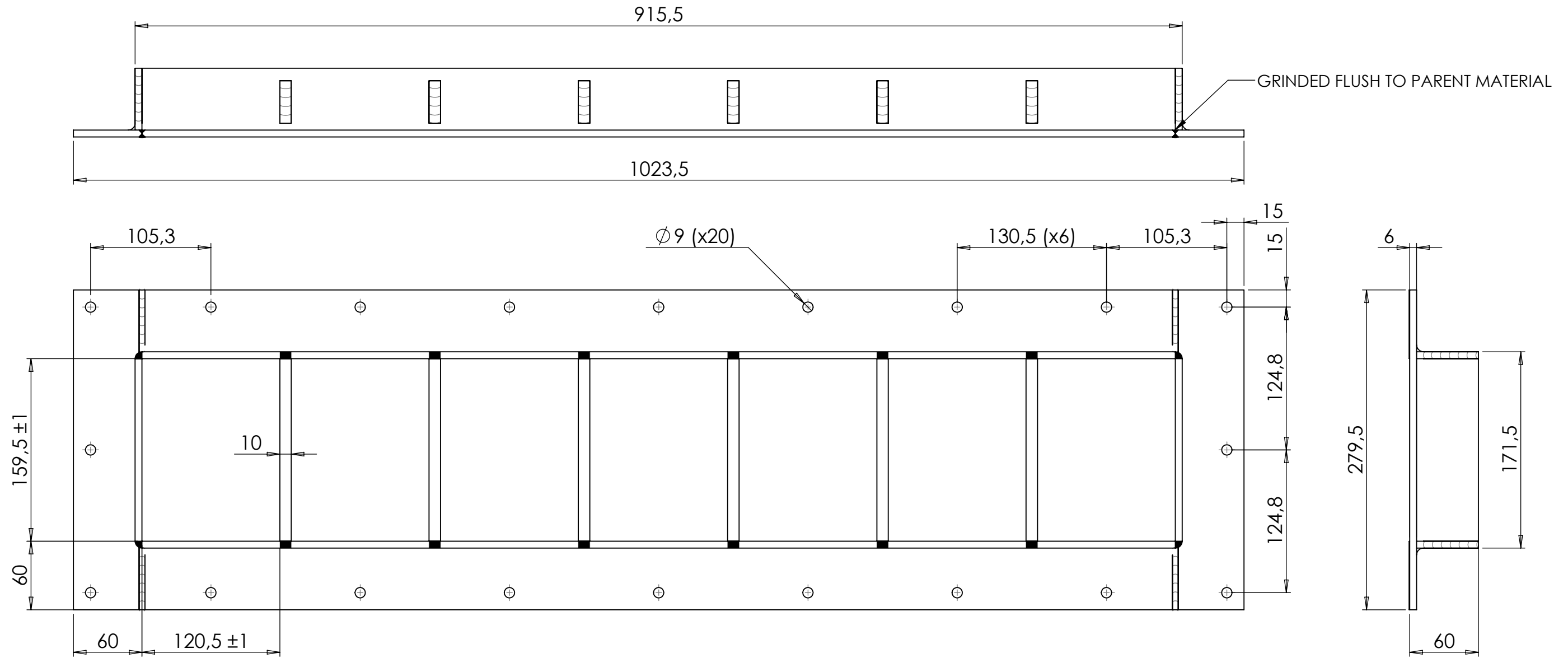

Ritad Drawn	Kontr. Check	Granskad Reviewed	Godkänd Approved	Tolerans där ej annat anges Tolerance unless otherwise not stated. ISO 13920-CF	Smst. nr. Assembly drawing no.	Ersätter Replaces	E
JA	JA	LS	ML	Ytjämnhet där ej annat anges. Surface finish otherwise not stated.	Material	Ersatt av Replaced of	Vikt Weight
191203	200123	200123	200123	Alla mått och uppgifter avser färdig produkt om ej annat anges. All measures and other information refer to finished products unless otherwise not stated.		Kund ordernr. Customer order no.	
				RGG-4x7 INFORMATION DRAWING		Ritn. nr. Draw. no.	Rev.
						1190780	A