

THIS DOCUMENT MUST NOT BE COPIED WITHOUT OUR WRITTEN PERMISSION, AND THE CONTENTS THEREOF MUST NOT BE IMPARTED TO A THIRD PARTY NOR BE USED FOR ANY UNAUTHORIZED PURPOSE. CONTRAVENTION WILL BE PROSECUTED.

REVISIONS			
REV.	DESCRIPTION	DATE	SIGNATURE
A		2019-07-30	JA

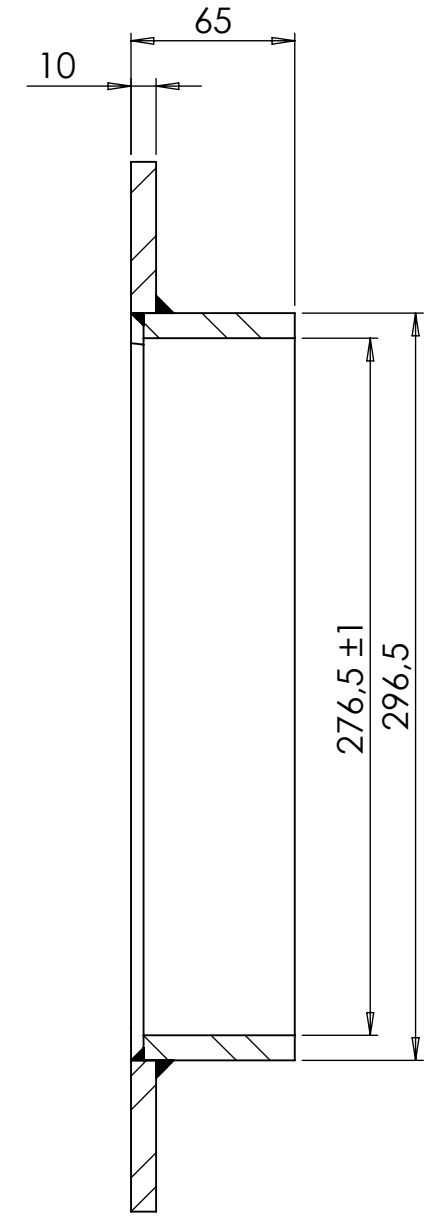

SECTION A-A

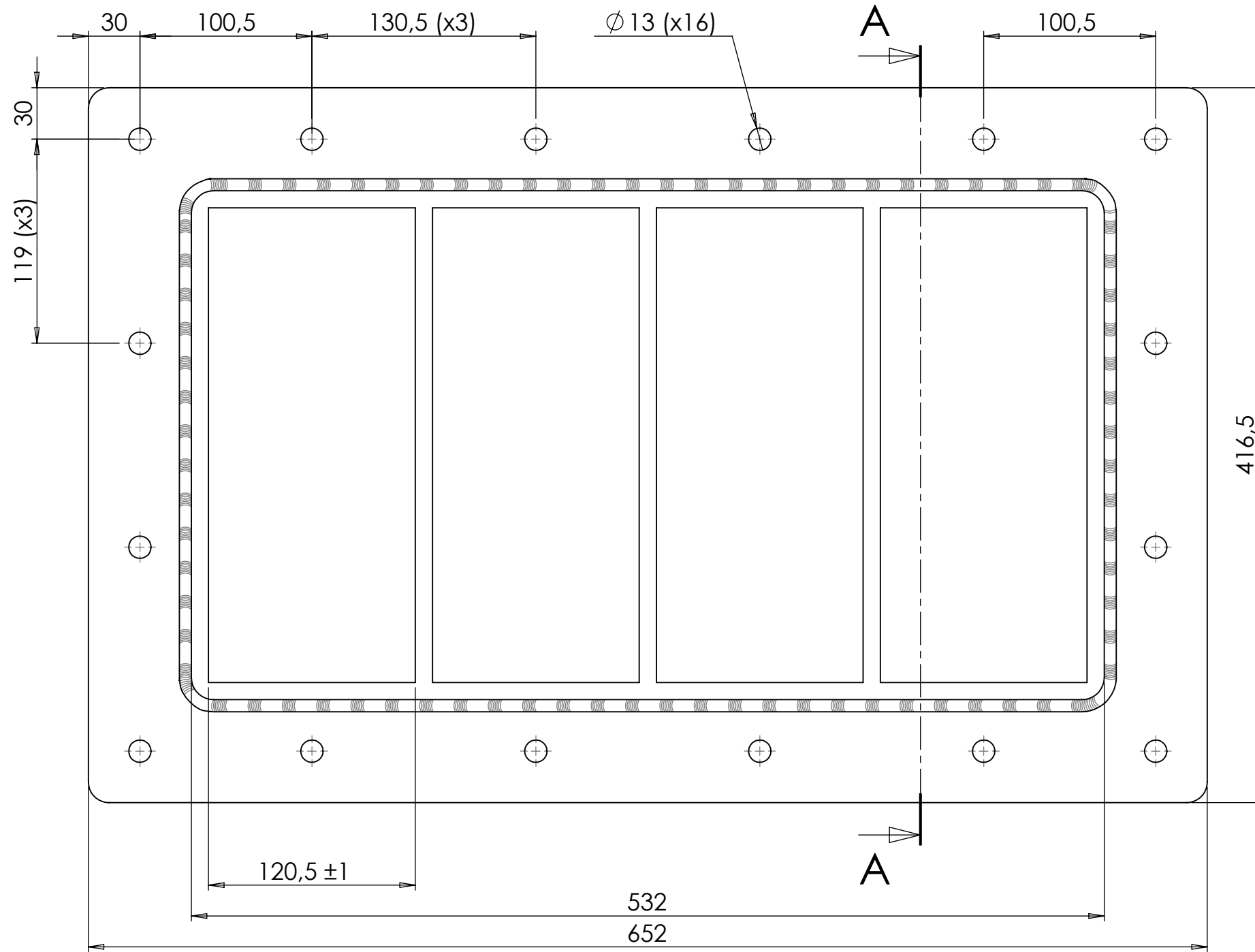
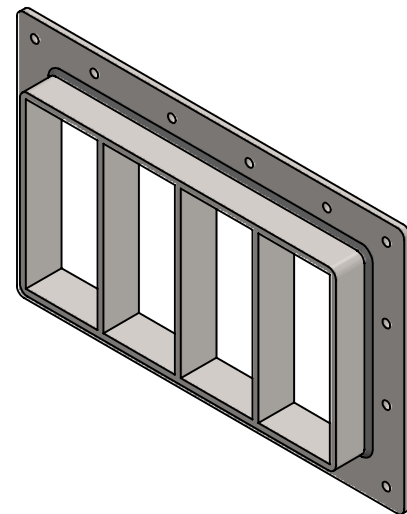

Ritad Drawn	Kontr. Check	Granskad Reviewed	Godkänd Approved	Tolerans där ej annat anges Tolerance unless otherwise not stated. ISO 13920-BF	Smst. nr. Assembly drawing no.	Ersätter Replaces	E
JA	JA	JF	BJ	Ytjämnhet där ej annat anges. Surface finish otherwise not stated.	Material	Ersatt av Replaced of	Vikt Weight
190729	190802	190809	190812			Alla mått och uppgifter avser färdig produkt om ej annat anges. All measures and other information refer to finished products unless otherwise not stated.	
				RGSFB-8x4 INFORMATION DRAWING		Kund ordernr. Customer order no	
						Ritn. nr. Draw. no.	Rev.
						1190388	A