

# Putting Safety First



## MCT Brattberg Product Catalog



# Product program



## At Sea

Maritime and offshore. Cable and pipe transits are primarily used for applications in hazardous maritime and offshore environments.



## Under Pressure

Custom designed pressure sealings up to 100 bar water pressure.



## On Land

Transits for high risk land-based applications protecting people, environment and vital industries.

# Product program



## E-Series

The E-series has built-in protection against EMI, EMP and ESD. Protection against lightning strikes, grounding and bonding of communication, instruments, power, braid, wire armored (AC and TECK 90) cables and copper pipes.



## ATEX and IECEx

Atex concerns all products to be used in places where explosive atmospheres may arise.



## On Train

Putting safety on rolling stock.

### DISCLAIMER

The author and publisher of this catalogue intend that this catalogue contain only general discussions and information; it is not intended to be comprehensive or to address all the possible contexts and situations involving the products and processes described herein. This catalogue is designed for generic study or research use only and is not a substitute for specific training or experience when utilizing the products and processes discussed herein. Nor is this catalogue intended to serve as a substitute for any proper training and/or certification needed for operation of the products and processes described herein. Accordingly, this catalogue is meant to be advisory and is not intended for specific application. Each application of the products and/or processes described herein may differ and the specifics involved must be addressed separately and individually depending on your situation.

MCT Brattberg (the "Company") assumes no liability for any use of or reliance upon any material contained or referenced in this catalogue; the use of this catalogue is at your own risk. THE COMPANY MAKES NO WARRANTIES, EXPRESS OR IMPLIED, INCLUDING WARRANTIES AS TO MERCHANTABILITY, AS TO THE FITNESS OF THE CATALOGUE OR ITS CONTENTS FOR ANY PARTICULAR USE OR PURPOSE, NON-INFRINGEMENT, OR AS TO THE ACCURACY, APPLICABILITY, OR COMPLETENESS OF THE CONTENTS OF THE CATALOGUE, AND SHALL NOT BE LIABLE

FOR ANY LOSS OR DAMAGE, DIRECTLY OR INDIRECTLY, ARISING FROM THE USE OF SUCH CATALOGUE OR FOR CONSEQUENTIAL DAMAGES. In no event shall Company be liable for: (a) punitive, incidental or consequential damages arising out of the use of the information from this catalogue, including, but not limited to, damage to persons or property, loss of use, loss of time, inconvenience, equipment rental, loss of earnings or profits, loss of business opportunities, or any other commercial loss, or (b) any losses, claims, damages, expenses, liabilities or costs (including legal fees) resulting directly or indirectly from use of the material in this CATALOGUE, WHICH IS PROVIDED "AS IS," AND WITHOUT WARRANTIES. The conditions in this paragraph apply to any acts, omissions and negligence of Company that would give rise to a course of legal action. The reader hereby agrees to indemnify and hold harmless Company its officers, directors, shareholders, employees, agents, subsidiaries, affiliates, parent companies and successors in interest against all claims and expenses (including attorney fees) arising from the use of any information in the catalogue. Further, Company is not responsible for any warranties of any nature made by any representative or agent that have not also been agreed to in writing by an officer of the Company.

364 - 388174v1 056390/000001

# Our History

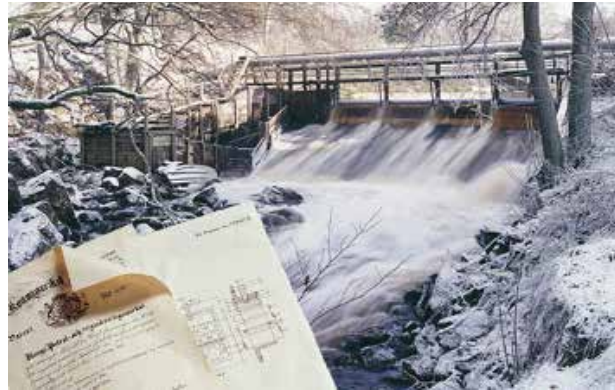

MCT Brattberg's origins reach back to 1759, a time when Lyckeåborg, just outside in southern Sweden, was designated the site for the construction of a copper hammer. The Lyckeby River waterfall was the ideal location for powering the hammer.

The company's modern history started after World War II. The mechanical workshop made a variety of products, among them the wellknown cut nail. The 1950s saw the manufacture of a new product, the MCT Brattberg cable and pipe transit, named after inventor Nils Brattberg.

## The original cable transit is constantly evolving

Mister Nils Brattberg invented a simple but clever idea of a frame with insert blocks and an end seal. The MCT Brattberg system was patented worldwide. In the 1950s the oil rigs and nuclear power stations demanded cable and pipe installations with proven safety records. The MCT Brattberg system quickly became a worldwide solution, because of its high performance and safety features. And we've been improving it ever since.

Some examples are: In the 1970s, the round RGP frame was introduced. At first it was designed for core-drilled holes in concrete. Today it is even installed in the decks and bulkheads of ships. In 1986, we introduced the Lycron rubber for our insert blocks. The same year saw the launch of the composite compression plate

with integrated compression bolt. In 1994, came the Pre-lubricated blocks and saves a great deal of time during installation. 1997, we introduced AddBlock, the universal block with increased flexibility in the packing. 1999, came the U-blocks and Plugs. Together with the AddBlocks the packing became even more flexible. 2018, was the HandiBlock a new blocksystem designed to minimize errors and wastage.

MCT Brattberg has an extensive global dealer network, which ensures the product's availability in most markets. Exports from Sweden constitute roughly 95% of sales.

Comprehensive documentation shows that our products and systems resistance to fire, water, gas and pressure meets the latest safety requirements.

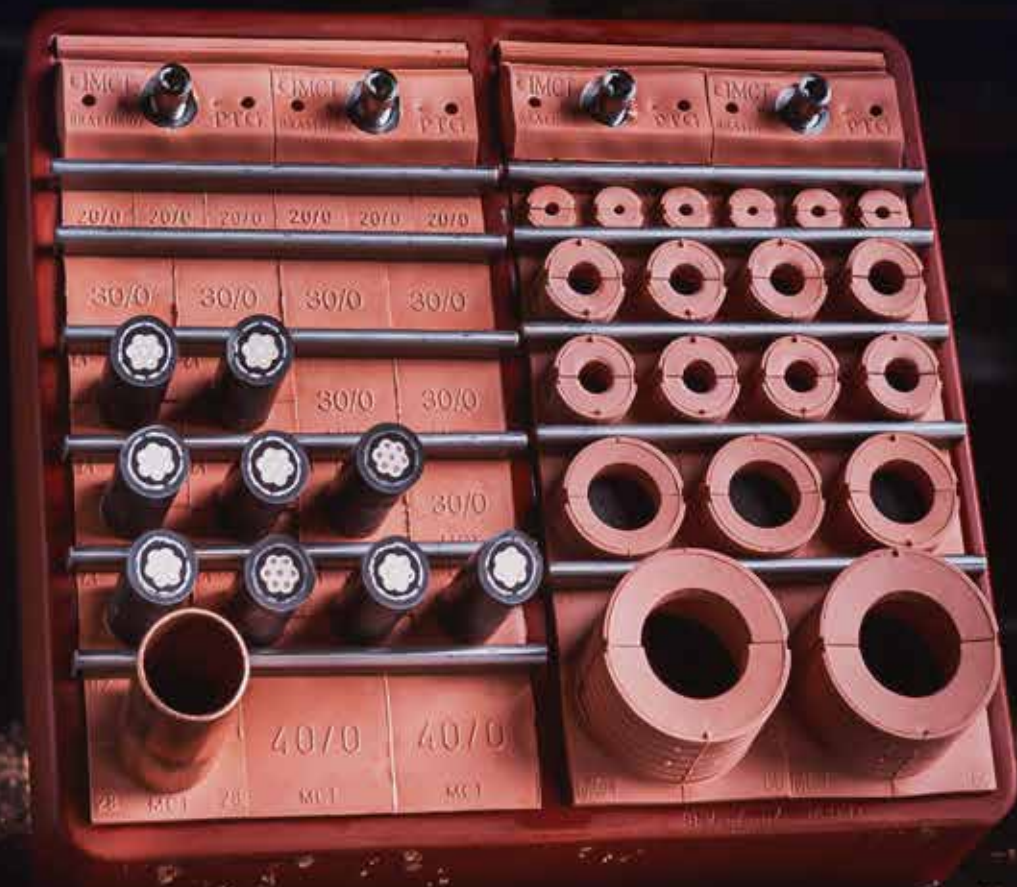



## Putting safety first

**It's the core of our business concept. Our transits protects people from harm of fire, pressure, gas and keeping the environment safe from dangerous chemicals.**

MCT Brattberg's concept for cable and pipe transits has led the market for over half a century by putting safety first.

Together with independent test institutes, we have developed testing methods and specifications that will guarantee seals that can withstand the most extreme conditions on land and at sea. Ever since receiving our first patent in 1952 we have led development and continually launch new products. We now have a flexible range of products suitable for a variety of situations, tested and approved by various test institutes worldwide.

A ship's structure is subject to constant and varying motions due to wave action and propulsion. Furthermore, it may expand and contract when subject to temperature variation. In turn, these actions expose transit frames to extremely powerful forces, conditions rarely occur with land-based applications involving static walls. This plays crucial roles for the safety of choice of design, materials, and assembly.

The safety of a system depends on the highest standard of design and fabrication along the total production chain. We use a hard-tipped circular metal saw as this produces a smooth even cut at the ends of

each bar at a 90 angle to the sides. This allows a flush joint to be achieved when forming the rectangular frame ready for welding.

Our robot welding is critical to producing transit frames with the highest safety standard, not only welding technique but also the weld joint design.

MCT Brattberg's concept for cable and pipe transits has led the market for over half a century by putting safety first.

Together with independent test institutes, we have developed testing methods and specifications that will guarantee seals that can withstand the most extreme conditions on land and at sea. Ever since receiving our first patent in 1952 we have led development and continually launch new products. We have a flexible range of products suitable for a variety of situations, tested and approved by various test institutes worldwide.

The structure of this product catalogue is designed to facilitate finding individual products and giving detailed specifications on them.

If you require any additional information about our products or their installation. Please contact us at one of the addresses provided at the end of this catalogue or on our website [rgplan.mctbrattberg.com](http://rgplan.mctbrattberg.com)

## Frames

The design, materials, construction and finish of frames play decisive roles in determining the safety of frames in withstanding constant stress in maritime and land-based environments.



## Cable management

Before working with insert blocks, cable management has to be carried out. Basically, this means that all cables passing through frames must have enough movement to allow them to be positioned correctly to facilitate fitting the insert blocks.



## Professional installation

No matter how many safety features are built into the components of cable and pipe transits, they can only be realized through correct installation. This means that transits must be complemented with training to maximize the safety awareness in all stakeholders.



## Testing and inspection

Testing for certification purposes is carried out in independent laboratories throughout the world. The Fire Test Procedure (FTP Codes) Standards, however, apply equally to all laboratories, no matter their location.





Welded RGS transit



Casting into concrete RGB transit

## Comprehensive benefits

MCT Brattberg cable and pipe transits are designed and manufactured to provide maximum benefits to all concerned as shown below.

### System concept

- The system is comprehensive, i.e. contains a complete range of frames, blocks, insulation, collars and products.
- Long-term reliability of all components for example, frames and insert blocks continue to provide an effective seal over the long term even when continually exposed to adverse conditions.
- A warranty period that support long-term reliability and gives confidence in products and supplier.
- The system provides the application flexibility needed to quickly configure and install all types of cable and pipe transit.
- The design and features of each type of components, e.g. insert blocks with clear identification, tight tolerances and self-lubrication, make them easy to install.
- Costs are reduced and assembly facilitated by no special tools required to install transits.
- Packing guides are available to show how best to configure insert blocks and cable within frames.
- Transit design planning software is available for engineers/designers to save time and effort involved with configuring transits.
- To ensure consistent quality of all system components, their production is governed by an accepted and independent QA/QC system like ISO 9001.
- Transit components are durable and stable enough to allow later disassembly.





Bolted RGG transit



RGP transit placed in a drilled hole.  
No compression plate or final seal is required

## Transit frames

- The frames are strong enough to withstand extreme conditions, e.g. shock and vibration of ship bulkheads and decks.
- Each corner is multiple-welded (at least two welds) to meet the requirements of a destruction test.
- Robotic welding is used to maintain uniform and consistent high-quality welds.
- Tight dimensional tolerances to maintain the defined functionality of insert blocks and other components.
- The inner surfaces are smooth and free from residual weld spatter to facilitate insert block packing.

## Insert blocks

- The cable/pipe diameter can be clearly identified on each insert block.
- The blocks are made of a self-extinguishing material.
- The blocks are self-lubricated to facilitate installation.
- The blocks retain their shape over the long term to maintain correct functionality.
- The blocks do not crack, melt, harden or become brittle under normal environmental conditions.
- The blocks do not release corrosive gases such as fluorine, chlorine, bromine and iodine when subject to fire.
- The blocks do not deteriorate when under attack by rodents, insects or microorganisms.
- The blocks are moulded to tight tolerances to ensure uniform and accurate sizing.
- Block design prevents displacement after installation.
- The blocks result in minimal waste during installation.



# At Sea



Putting  
safety first

# Safety above all



## DISCLAIMER

The author and publisher of this catalogue intend that this catalogue contain only general discussions and information; it is not intended to be comprehensive or to address all the possible contexts and situations involving the products and processes described herein. This catalogue is designed for generic study or research use only and is not a substitute for specific training or experience when utilizing the products and processes discussed herein. Nor is this catalogue intended to serve as a substitute for any proper training and/or certification needed for operation of the products and processes described herein. Accordingly, this catalogue is meant to be advisory and is not intended for specific application. Each application of the products and/or processes described herein may differ and the specifics involved must be addressed separately and individually depending on your situation.

MCT Brattberg (the "Company") assumes no liability for any use of or reliance upon any material contained or referenced in this catalogue; the use of this catalogue is at your own risk. THE COMPANY MAKES NO WARRANTIES, EXPRESS OR IMPLIED, INCLUDING WARRANTIES AS TO MERCHANTABILITY, AS TO THE FITNESS OF THE CATALOGUE OR ITS CONTENTS FOR ANY PARTICULAR USE OR PURPOSE, NON-INFRINGEMENT, OR AS TO THE ACCURACY, APPLICABILITY, OR COMPLETENESS OF THE CONTENTS OF THE CATALOGUE, AND SHALL NOT BE LIABLE

FOR ANY LOSS OR DAMAGE, DIRECTLY OR INDIRECTLY, ARISING FROM THE USE OF SUCH CATALOGUE OR FOR CONSEQUENTIAL DAMAGES. In no event shall Company be liable for: (a) punitive, incidental or consequential damages arising out of the use of the information from this catalogue, including, but not limited to, damage to persons or property, loss of use, loss of time, inconvenience, equipment rental, loss of earnings or profits, loss of business opportunities, or any other commercial loss, or (b) any losses, claims, damages, expenses, liabilities or costs (including legal fees) resulting directly or indirectly from use of the material in this CATALOGUE, WHICH IS PROVIDED "AS IS," AND WITHOUT WARRANTIES. The conditions in this paragraph apply to any acts, omissions and negligence of Company that would give rise to a course of legal action. The reader hereby agrees to indemnify and hold harmless Company its officers, directors, shareholders, employees, agents, subsidiaries, affiliates, parent companies and successors in interest against all claims and expenses (including attorney fees) arising from the use of any information in the catalogue. Further, Company is not responsible for any warranties of any nature made by any representative or agent that have not also been agreed to in writing by an officer of the Company.

364 - 388174v1 056390/000001

# Product program

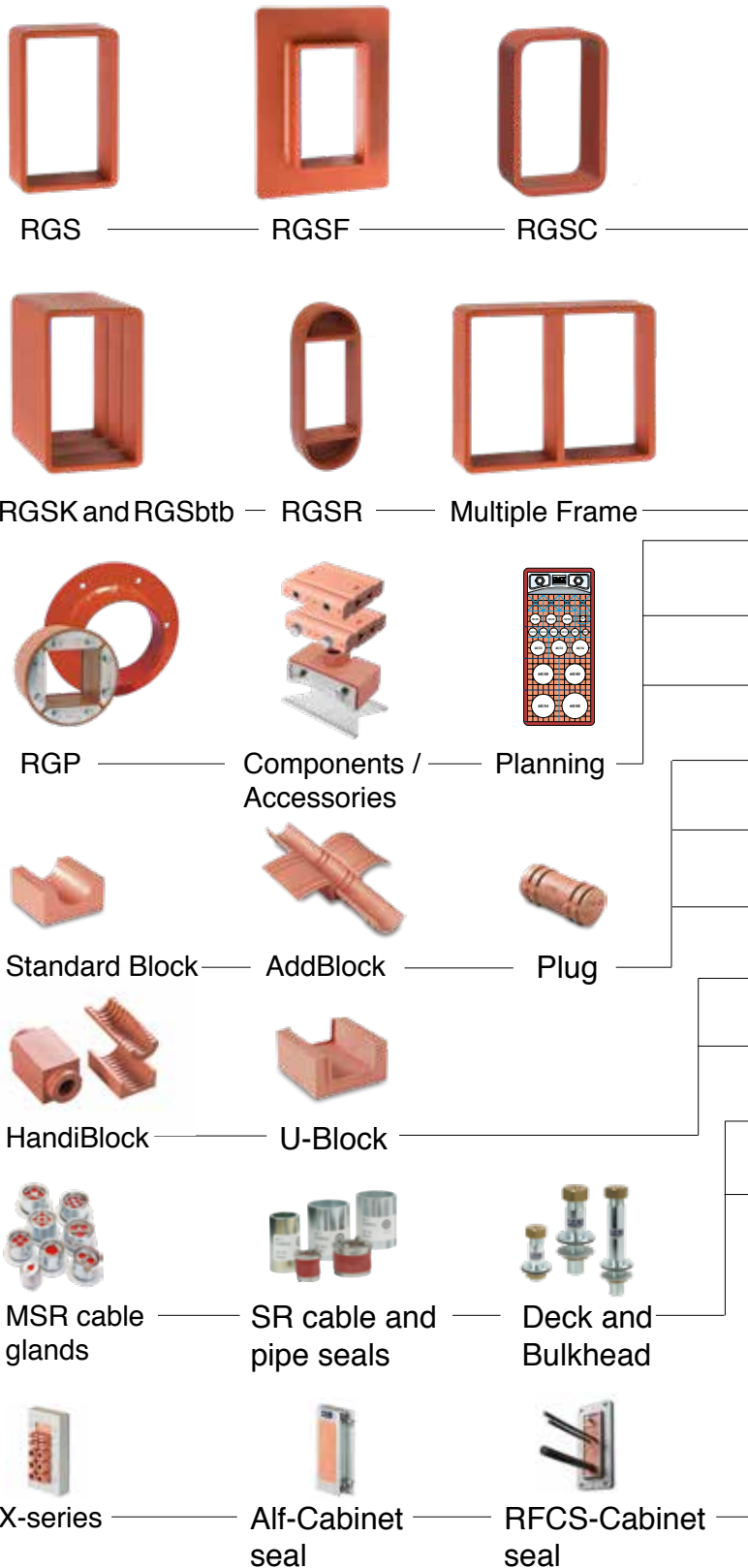

Putting Safety First	Page 4
Certification and testing	Page 5
The original cable transit	Page 6
Special seals	Page 7
RGS	Pages 8-9
RGSF	Pages 10-11
RGSC	Pages 12-13
RGSK and RGSbtb	Pages 14-16
RGSR	Page 17
Multiple Frame	Page 17
RGP	Pages 18-19
Accessories	Pages 20-21
Planning	Pages 22-25
Standard Block	Pages 26-27
AddBlock	Page 28
Plug	Page 29
HandiBlock	Pages 30
U-Block	Pages 31
MSR, SR	Pages 32-33
Deck and Bulkhead	Pages 34-35
X-series, Alf, RFCS	Pages 36-39
Under pressure	Pages 41-47
Addresses see back page	

# The MCT Brattberg

# Putting Safety First

MCT Brattberg are constantly taking new steps to ensure the correct standard of assembled MCT transits.

We now offer:

## **INSPECTION**

- Ensuring MCT's meet relevant standards.
- Ensure that MCT's were installed to manufacturer's instructions.

## **TESTING**

Pressure testing transit to customer requirements.

## **TROUBLE SHOOTING**

Assist and Consult on installation of difficult installations.

## **TRAINING**

Conduct onshore and offshore training classes to ensure that MCT's will be installed to code and to manufacturer's instruction.



# Tested, approved and certified

Since the early 1950s, when we first started specializing in fireproof and pressure-sealed transits, quality testing and classification has been essential.

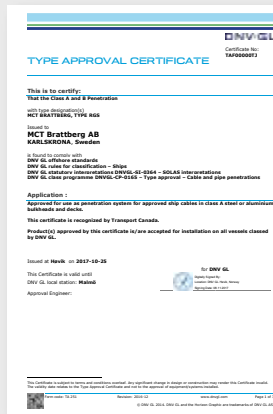

In 1986 our sealing method and quality system was adapted to meet the rigid requirements of the offshore industry and have been continuously to current requirements. Today MCT Brattberg is assessed and certified by DNV, in accordance with the Quality and Environment Management system standard EN ISO 9001 and 14001, for the design, manufacture and supply of fire barrier and sealed transit systems associated with cable and pipe routes in building and marine environments. As a direct result of this achievement, quality and environmental assessments are carried out by DNV twice annually.

Our products are tested and certified by a long list of customers, laboratories and certification organizations.

ABS, American Bureau of Shipping - Canadian Coast Guard - Bureau Veritas - China Classification Society - Australian Maritime Safety Authority - DNV-GL, Det Norske Veritas - Korean Register of Shipping - Lloyd's Register of Shipping - Nippon Kaiji Kyokai Polski Rejestr Statkow - Germanischer Lloyd - Swedish Adm. of Shipping and Navigation - Croatian Register of Shipping - RINA, Registro Italiano Navale - Russian Maritime Register - US Coast Guard - US Navy - Underwriters Laboratories Inc. - Underwriters Laboratories of Canada

MCT Brattberg is also certified according to MED, Marine Equipment Directive (via Lloyd's Register of Shipping)

Please consult MCT Brattberg for latest updated certificates and approvals.

# The original cable transit

Based on the simple but clever idea of a frame with Insert Blocks and an end seal, the MCT Brattberg is the original transit system.

The MCT Brattberg system was patented in the early 1950s. When oil rigs and nuclear power stations demanded cable and pipe installations with proven safety records, the MCT Brattberg system became a worldwide solution, we've been improving it ever since. Comprehensive documentation shows that its resistance to fire, water, gas and pressure meets the latest safety requirements.

## The industry standard

Our own experience has shown that for a standard frame used for maritime applications, an internal width of 120.5 mm (4.74") a depth of 60 mm (2.36") and wall thickness of 10 mm (0.39") are optimal window sizes for maintaining structural strength and for fitting insert blocks. The welded corners are rounded for added strength. Both single and multiple transits frames are available.

The dimensions of the various frames have become the industry standard simply because these types of frames were the first to be introduced and have proved successful over time.

## Built in flexibility

The comprehensive range of frames, standard Blocks and other components of our transits provides remarkable application flexibility. In addition, our product range covers insulation collars and special solutions for EMC transits, SR cable and pipe seals, deck/bulkhead glands.

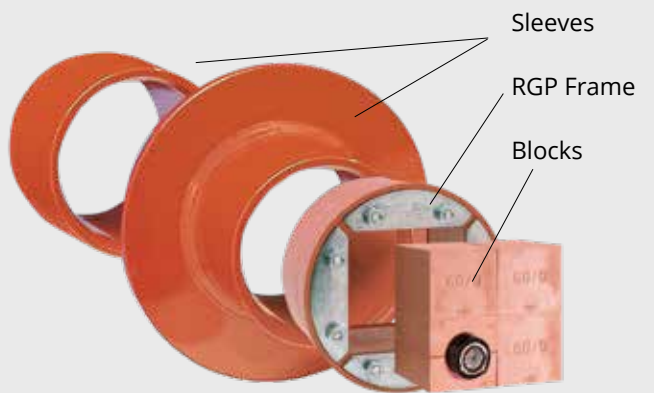
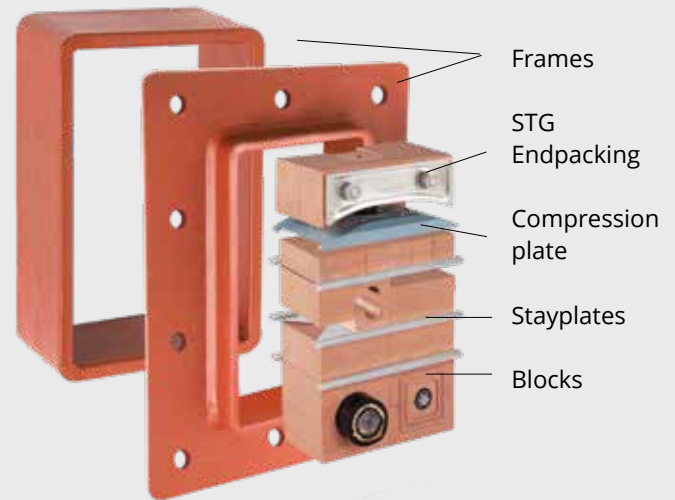
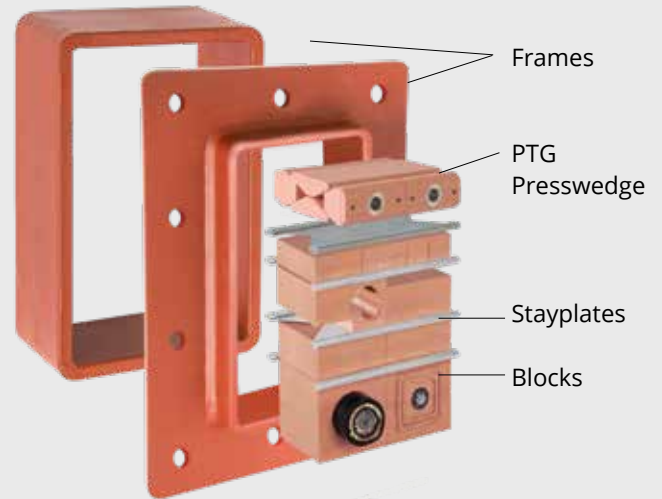



# Special products for specific uses

MCT Brattberg manufactures a number of special products. High pressure secure cable transits, transits for wave guides and blocks with built-in protection against electromagnetic pulse due to lightning or nuclear blast.

## High pressure seals

is an example of our special products. Several types of high pressure seals are available. Often these have been designed in collaboration with a customer. They are used, for example, in the supporting legs of oil rigs or in submarines. An example is the RGPH seal, which is certified up to 66.7 bar.

## The E-series

and components provide the same protection as the standard MCT Brattberg system but with added, built-in protection against electromagnetic pulses caused by lightning or nuclear blast.

They also give protection against interference, electronic sabotage and static electricity.

All dimensions are exactly the same as for the other MCT Brattberg components.

The E-series are approved for Grounding and Bonding.

## ATEX and IECEx certified transits

In explosion hazardous environments, it's important to have Ex equipment. MCT Brattberg has a specific program for this areas with products that are tested and certified according to the ATEX directive and the international IECEx. All dimensions are exactly the same as for the other MCT Brattberg components.

**For special products please consult MCT Brattberg.**



RGPH is certified up to 66,7 bar



EMC products for grounding and bonding.



Products to protect against explosions.

# RGS

## RGSO with removable end

RGS is MCT Brattberg's standard transit frame for marine applications. It has a standard internal width of 120 mm (4.72") and is 60 mm (2.36") deep. There are four sizes of RGS, denoted by 2, 4, 6 and 8 depending on their height. They may be used in both vertical and/or horizontal multiple frames.

The RGS is welded into an accurately pre-cut hole in the deck or bulkhead.

As with all our frames, RGS is produced in steel, stainless steel, or aluminium.

For installations where cables are already in place, specify RGSO, which has a removable end. RGS weight charts can be found on the next page.



Frame size	Size in mm								Size in inches							
	H(Height)	W (width) Multiple Frames							H	W (width) Multiple Frames						
		x 1	x 2	x 3	x 4	x 5	x 6	x n		x 1	x 2	x 3	x 4	x 5	x 6	x n
RGS-2	121	140,5	271	401,5	532	662,5	793	W = 10 + 130,5 x n	4.76	5.53	10.67	15.81	20.94	26.08	31.2	W = 0.40 + 5.14 x n
RGS-4	179,5	- "-	- "-	- "-	- "-	- "-	- "-		7.07	- "-	- "-	- "-	- "-	- "-	- "-	
RGS-6	238	- "-	- "-	- "-	- "-	- "-	- "-		9.37	- "-	- "-	- "-	- "-	- "-	- "-	
RGS-8	296,5	- "-	- "-	- "-	- "-	- "-	- "-		11.67	- "-	- "-	- "-	- "-	- "-	- "-	
RGS-2+2	242	- "-	- "-	- "-	- "-	- "-	- "-		9.53	- "-	- "-	- "-	- "-	- "-		
RGS-2+4	300,5	- "-	- "-	- "-	- "-	- "-	- "-		11.83	- "-	- "-	- "-	- "-	- "-		
RGS-2+6	359	- "-	- "-	- "-	- "-	- "-	- "-		14.13	- "-	- "-	- "-	- "-	- "-		
RGS-2+8	417,5	- "-	- "-	- "-	- "-	- "-	- "-		16.44	- "-	- "-	- "-	- "-	- "-		
RGS-4+4	359	- "-	- "-	- "-	- "-	- "-	- "-		14.13	- "-	- "-	- "-	- "-	- "-		
RGS-4+6	417,5	- "-	- "-	- "-	- "-	- "-	- "-		16.44	- "-	- "-	- "-	- "-	- "-		
RGS-4+8	476	- "-	- "-	- "-	- "-	- "-	- "-		18.74	- "-	- "-	- "-	- "-	- "-		
RGS-6+6	476	- "-	- "-	- "-	- "-	- "-	- "-		18.74	- "-	- "-	- "-	- "-	- "-		
RGS-6+8	534,5	- "-	- "-	- "-	- "-	- "-	- "-		21.04	- "-	- "-	- "-	- "-	- "-		
RGS-8+8	593	- "-	- "-	- "-	- "-	- "-	- "-		23.35	- "-	- "-	- "-	- "-	- "-		
RGS-2+2	232	140,5	n = number of frames wide. Tolerance single frame: Height ± 1 mm Width ± 1 mm Material thickness is 10 mm					9.13	5.53	n = number of frames wide. Tolerance single frame: Height ± 0.04", Width ± 0.04". Material thickness is 0.39".						
RGS-2+4	290,5	- "-						11.44	- "-							
RGS-2+6	349	- "-						13.74	- "-							
RGS-2+8	407,5	- "-						16.04	- "-							
RGS-4+4	349	- "-						13.74	- "-							
RGS-4+6	407,5	- "-						16.04	- "-							
RGS-4+8	466	- "-						18.35	- "-							
RGS-6+6	466	- "-						18.35	- "-							
RGS-6+8	524,5	- "-						20.65	- "-							
RGS-8+8	583	- "-						22.95	- "-							

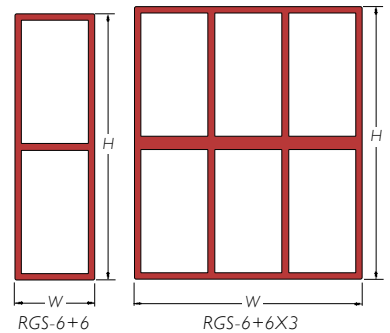
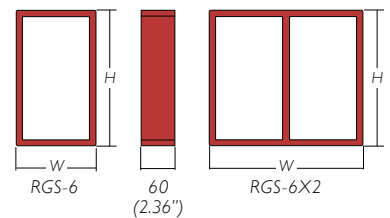

## WEIGHT CHART

Standard frames come in four sizes: 2, 4, 6 and 8. They are all the same width. Height differences are shown below. The material is 10 mm (0.39") thick

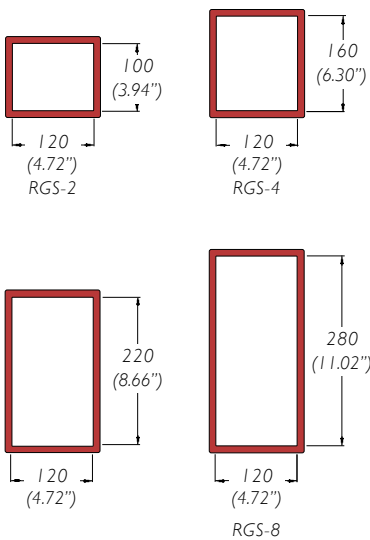

Material	Frame size	Weight in kilograms						Weight in pounds						
		W (width) Multiple Frames						W (width) MultipleFrames						
		x1	x2	x3	x4	x5	x6	x1	x2	x3	x4	x5	x6	
MILD STEEL	RGS-2	2,2	3,9	5,7	7,4	9,2	10,9	4,9	8,6	12,6	32,6	20,3	24,0	
	RGS-4	2,7	4,6	6,5	8,4	10,3	12,2	6,0	10,1	14,3	37,3	22,7	26,9	
	RGS-6	3,2	5,4	7,6	9,8	12,0	14,2	7,1	11,9	16,8	41,0	26,5	31,3	
	RGS-8	3,8	6,3	8,9	11,4	14,0	16,5	8,4	13,9	19,6	44,8	30,9	36,4	
	S355JR S355J2 S355K2	RGS-2+2	3,6	8,1	11,9	15,7	19,5	23,3	7,9	17,9	26,2	52,9	43,0	51,4
		RGS-2+4	4,2	8,8	12,8	16,7	20,7	24,6	9,3	19,4	28,2	56,7	45,6	54,2
		RGS-2+6	4,8	9,5	13,6	17,8	21,9	26,0	10,6	20,9	30,0	60,0	48,3	57,3
		RGS-2+8	5,5	10,3	14,7	19,1	23,5	27,9	12,1	22,7	32,4	64,4	51,8	61,5
	A36 AH36 DH36 EH36	RGS-4+4	4,8	9,5	13,6	17,8	21,9	26,0	10,6	20,9	30,0	60,0	48,3	57,3
		RGS-4+6	5,5	10,3	14,7	19,1	23,5	27,9	12,1	22,7	32,4	64,4	51,8	61,5
RGS-4+8		5,9	11,1	15,8	20,5	25,1	29,8	13,0	24,5	34,8	68,3	55,3	65,7	
RGS-6+6		5,9	11,1	15,8	20,5	25,1	29,8	13,0	24,5	34,8	68,3	55,3	65,7	
RGS-6+8		6,5	12,0	17,0	22,1	27,1	32,1	14,3	26,5	37,5	73,0	59,7	70,8	
RGS-8+8		7,2	12,9	18,3	23,7	29,1	34,5	15,9	28,4	40,3	78,0	64,2	76,1	
STAINLESS STEEL	RGS-2	2,2	4,0	5,8	7,6	9,4	11,2	4,9	8,8	12,8	33,5	20,7	24,7	
	RGS-4	2,8	4,7	6,7	8,6	10,6	12,6	6,2	10,4	14,8	38,1	23,4	27,8	
	RGS-6	3,3	5,5	7,8	10,0	12,3	14,5	7,3	12,1	17,2	41,9	27,1	31,7	
	RGS-8	3,9	6,5	9,1	11,7	14,3	16,9	8,6	14,3	20,1	45,9	31,5	37,3	
	I.4404	RGS-2+2	3,7	8,3	12,2	16,1	20,0	23,9	8,2	18,3	26,9	54,5	44,1	52,7
		RGS-2+4	4,3	9,0	13,1	17,1	21,2	25,2	9,5	19,8	28,9	58,2	46,7	55,6
		RGS-2+6	4,9	9,7	14,0	18,2	22,5	26,7	10,8	21,4	30,9	61,5	49,6	58,9
		RGS-2+8	5,6	10,6	15,1	19,6	24,1	28,6	12,3	23,4	33,3	65,9	53,1	63,1
	AISI 316L	RGS-4+4	4,9	9,7	14,0	18,2	22,5	26,7	10,8	21,4	30,9	61,5	49,6	58,9
		RGS-4+6	5,6	10,6	15,1	19,6	24,1	28,6	12,3	23,4	33,3	65,9	53,1	63,1
RGS-4+8		6,0	11,4	16,2	21,0	25,8	30,6	13,2	25,1	35,7	70,1	56,9	67,5	
RGS-6+6		6,0	11,4	16,2	21,0	25,8	30,6	13,2	25,1	35,7	70,1	56,9	67,5	
RGS-6+8		6,7	12,3	17,5	22,6	27,8	32,9	14,8	27,1	38,6	74,7	61,3	72,5	
RGS-8+8		7,4	13,2	18,8	24,3	29,9	35,4	16,3	29,1	41,4	80,0	65,9	78,0	
ALUMINIUM	RGS-2	0,8	1,4	2,0	2,6	3,2	3,8	1,8	3,1	4,4	11,5	7,1	8,4	
	RGS-4	1,0	1,6	2,3	3,0	3,6	4,3	2,2	3,5	5,1	13,0	7,9	9,5	
	RGS-6	1,1	1,9	2,7	3,4	4,2	5,0	2,4	4,2	6,0	14,3	9,3	11,0	
	RGS-8	1,3	2,2	3,1	4,0	4,9	5,8	2,9	4,9	6,8	15,7	10,8	12,8	
	EN AW-6082 EN AW-5086	RGS-2+2	1,3	2,8	4,2	5,5	6,9	8,2	2,9	6,2	9,3	18,5	15,2	18,1
		RGS-2+4	1,5	3,1	4,5	5,9	7,2	8,6	3,3	6,8	9,9	20,1	15,9	19,0
		RGS-2+6	1,7	3,3	4,8	6,2	7,7	9,1	3,7	7,3	10,6	21,2	17,0	20,1
		RGS-2+8	1,9	3,6	5,2	6,7	8,3	9,8	4,2	7,9	11,5	22,5	18,3	21,6
	EN AW-6082 EN AW-5086	RGS-4+4	1,7	3,3	4,8	6,2	7,7	9,1	3,7	7,3	10,6	21,2	17,0	20,1
		RGS-4+6	1,9	3,6	5,2	6,7	8,3	9,8	4,2	7,9	11,5	22,5	18,3	21,6
		RGS-4+8	2,1	3,9	5,5	7,2	8,8	10,4	4,6	8,6	12,1	24,0	19,4	22,9
		RGS-6+6	2,1	3,9	5,5	7,2	8,8	10,4	4,6	8,6	12,1	24,0	19,4	22,9
		RGS-6+8	2,3	4,2	6,0	7,7	9,5	11,2	5,1	9,3	13,2	25,6	20,9	24,7
		RGS-8+8	2,5	4,5	6,4	8,3	10,2	12,1	5,5	9,9	14,1	27,3	22,5	26,7

# RGSF and RGSFB

RGSF is a standard RGS transit frame with a flange that allows the frame to be welded into a hole which is slightly larger than the frame.

RGSF comes in the four standard sizes, 2, 4, 6 and 8, and has the standard measurements of the RGS, but with the added width of the flange: 60 mm (2.36") wide and 10 mm (0.39") thick.

RGSF can also be installed in multiple frames, see page 17.

For installations where cables are already in place, specify RGSFO which has a removable end.

The RGSFB transit frame is similar to RGSF except that it is bolted to the deck or bulkhead. The bolted frames can be used in areas where hot working is prohibited, or when the stress level induced by welding is unacceptable. RGSFB frames are supplied in kit form, complete with drilled holes, bolts, nuts, washers and a gasket or sealing compound. The standard sizes and weights are the same as for RGSF. For installations where cables are already in place, specify RGSFBO which has a bolted removable end.

Frame size	Size in mm								Size in inches							
	H (Height)	W (width) Multiple Frames							H	W (width) Multiple Frames						
		x 1	x 2	x 3	x 4	x 5	x 6	x n		x 1	x 2	x 3	x 4	x 5	x 6	x n
RGSF/B-2	241	60,5	391	521.5	652	782.5	913	W = 130+ 130,5 x n	9.49	10.26	15.39	20.53	25.67	30.81	35.94	W = 5.12 + 5.14 x n
RGSF/B-4	299,5	- "	- "	- "	- "	- "	- "		11.79	- "	- "	- "	- "	- "	- "	
RGSF/B-6	358	- "	- "	- "	- "	- "	- "		14.09	- "	- "	- "	- "	- "	- "	
RGSF/B-8	416,5	- "	- "	- "	- "	- "	- "		16.40	- "	- "	- "	- "	- "	- "	
RGSF/B-2+2	362	- "	- "	- "	- "	- "	- "	- "	14.25	- "	- "	- "	- "	- "	- "	
RGSF/B-2+4	420,5	- "	- "	- "	- "	- "	- "	- "	16.56	- "	- "	- "	- "	- "	- "	
RGSF/B-2+6	479	- "	- "	- "	- "	- "	- "	- "	18.86	- "	- "	- "	- "	- "	- "	
RGSF/B-2+8	537,5	- "	- "	- "	- "	- "	- "	- "	21.16	- "	- "	- "	- "	- "	- "	
RGSF/B-4+4	479	- "	- "	- "	- "	- "	- "	- "	18.86	- "	- "	- "	- "	- "	- "	
RGSF/B-4+6	537,5	- "	- "	- "	- "	- "	- "	- "	21.16	- "	- "	- "	- "	- "	- "	
RGSF/B-4+8	596	- "	- "	- "	- "	- "	- "	- "	23.46	- "	- "	- "	- "	- "	- "	
RGSF/B-6+6	596	- "	- "	- "	- "	- "	- "	- "	23.46	- "	- "	- "	- "	- "	- "	
RGSF/B-6+8	654,5	- "	- "	- "	- "	- "	- "	- "	25.77	- "	- "	- "	- "	- "	- "	
RGSF/B-8+8	713	- "	- "	- "	- "	- "	- "	- "	28.07	- "	- "	- "	- "	- "	- "	
RGSF/B-2+2	352	260,5	n = number of frames wide. Tolerance single frame: Height ± 1 mm Width ± 1 mm Material thickness is 10 mm  <b>RGSF-frames are normally supplied with straight corners but are also available with round corners with a radius of 63 mm</b>						13.86	10,26	n = number of frames wide. Tolerance single frame: Height ± 0.04", Width ± 0.04". Material thickness is 0.39".  <b>RGSF-frames are normally supplied with straight corners but are also available with round corners with a radius of 2.48".</b>					
RGSF/B-2+4	410,5	- "							16.16	- "						
RGSF/B-2+6	469	- "							18.46	- "						
RGSF/B-2+8	527,5	- "							20.77	- "						
RGSF/B-4+4	469	- "							18.46	- "						
RGSF/B-4+6	527,5	- "							20.77	- "						
RGSF/B-4+8	586	- "							23.07	- "						
RGSF/B-6+6	586	- "							23.07	- "						
RGSF/B-6+8	644,5	- "							25.37	- "						
RGSF/B-8+8	703	- "							27.68	- "						

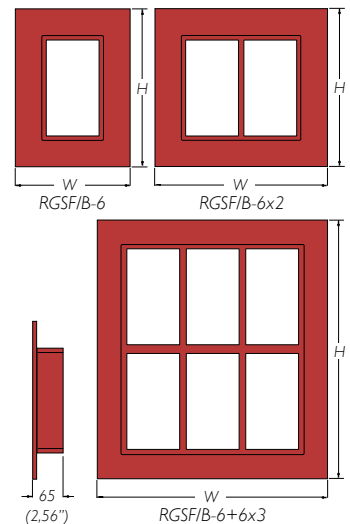



Standard frames come in four sizes: 2, 4, 6 and 8. They are all the same width. Height differences are shown below. The material is 10 mm (0.39") thick.

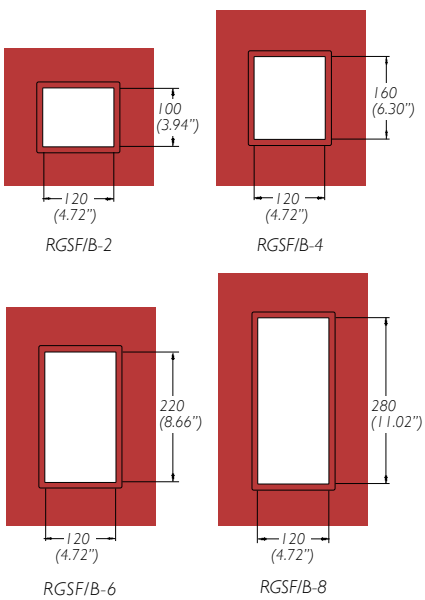

Material	Frame size	Weight in kilograms						Weight in pounds						
		W (width) Multiple Frames						W (width) Multiple Frames						
		x1	x2	x3	x4	x5	x6	x1	x2	x3	x4	x5	x6	
MILD STEEL	RGSF/B-2	5,9	8,9	11,8	14,8	17,8	20,7	13,0	19,6	26,0	32,6	39,2	45,6	
	RGSF/B-4	7,0	10,3	13,6	16,9	20,2	23,4	15,4	22,7	30,0	37,3	44,5	51,6	
	RGSF/B-6	8,0	11,5	15,1	18,6	22,1	25,6	17,6	25,4	33,3	41,0	48,7	56,4	
	RGSF/B-8	9,0	12,8	16,5	20,3	24,0	27,8	19,8	28,2	36,4	44,8	52,9	61,3	
	S355JR S355J2 S355K2	RGSF/B-2+2	8,4	13,9	19,0	24,0	29,1	34,1	18,5	30,6	41,9	52,9	64,2	75,2
		RGSF/B-2+4	9,5	15,3	20,5	25,7	30,9	36,1	20,9	33,7	45,2	56,7	68,1	79,6
		RGSF/B-2+6	10,6	16,5	21,9	27,2	32,6	37,9	23,4	36,4	48,3	60,0	71,9	83,6
		RGSF/B-2+8	11,7	17,9	23,5	29,2	34,8	40,4	25,8	39,5	51,8	64,4	76,7	89,1
	A36 AH36 DH36 EH36	RGSF/B-4+4	10,6	16,5	21,9	27,2	32,6	37,9	23,4	36,4	48,3	60,0	71,9	83,6
		RGSF/B-4+6	11,7	17,9	23,5	29,2	34,8	40,4	25,8	39,5	51,8	64,4	76,7	89,1
		RGSF/B-4+8	12,8	19,2	25,1	31,0	36,9	42,8	28,2	42,3	55,3	68,3	81,4	94,4
		RGSF/B-6+6	12,8	19,2	25,1	31,0	36,9	42,8	28,2	42,3	55,3	68,3	81,4	94,4
	RGSF/B-6+8	13,9	20,6	26,9	33,1	39,4	45,6	30,6	45,4	59,3	73,0	86,9	100,5	
	RGSF/B-8+8	15,0	22,1	28,7	35,4	42,0	48,6	33,1	48,7	63,3	78,0	92,6	107,1	
STAINLESS STEEL	RGSF/B-2	6,1	9,1	12,1	15,2	18,2	21,2	13,4	20,1	26,7	33,5	40,1	46,7	
	RGSF/B-4	7,2	10,6	13,9	17,3	20,7	24,0	15,9	23,4	30,6	38,1	45,6	52,9	
	RGSF/B-6	8,2	11,8	15,4	19,0	22,7	26,3	18,1	26,0	34,0	41,9	50,0	58,0	
	RGSF/B-8	9,2	13,1	16,9	20,8	24,6	28,5	20,3	28,9	37,3	45,9	54,2	62,8	
	1.4404	RGSF/B-2+2	8,6	14,3	19,5	24,7	29,8	35,0	19,0	31,5	43,0	54,5	65,7	77,2
		RGSF/B-2+4	9,7	15,7	21,0	26,4	31,7	37,0	21,4	34,6	46,3	58,2	69,9	81,6
		RGSF/B-2+6	10,9	16,9	22,4	27,9	33,4	38,9	24,0	37,3	49,4	61,5	73,6	85,8
		RGSF/B-2+8	12,0	18,4	24,2	29,9	35,7	41,4	26,5	40,6	53,4	65,9	78,7	91,3
	AISI 316L	RGSF/B-4+4	10,9	16,9	22,4	27,9	33,4	38,9	24,0	37,3	49,4	61,5	73,6	85,8
		RGSF/B-4+6	12,0	18,4	24,2	29,9	35,7	41,4	26,5	40,6	53,4	65,9	78,7	91,3
		RGSF/B-4+8	13,1	19,7	25,8	31,8	37,9	43,9	28,9	43,4	56,9	70,1	81,4	96,8
		RGSF/B-6+6	13,1	19,7	25,8	31,8	37,9	43,9	28,9	43,4	56,9	70,1	83,6	96,8
	RGSF/B-6+8	14,3	21,1	27,5	33,9	40,3	46,7	31,5	46,5	60,6	74,7	88,8	103,0	
	RGSF/B-8+8	15,4	22,7	29,5	36,3	43,0	49,8	34,0	50,0	65,0	80,0	94,8	109,8	
ALUMINIUM	RGSF/B-2	2,1	3,1	4,1	5,2	6,2	7,3	4,6	6,8	9,0	11,5	13,7	16,1	
	RGSF/B-4	2,5	3,6	4,8	5,9	7,1	8,2	5,5	7,9	10,6	13,0	15,7	18,1	
	RGSF/B-6	2,8	4,0	5,3	6,5	7,7	9,0	6,2	8,8	11,7	14,3	17,0	19,8	
	RGSF/B-8	3,2	4,5	5,8	7,1	8,4	9,7	7,1	9,9	12,8	15,7	18,5	21,4	
	EN AW-6082 EN AW-5086	RGSF/B-2+2	2,9	4,9	6,7	8,4	10,2	11,9	6,4	10,8	14,8	18,5	22,5	26,2
		RGSF/B-2+4	3,3	5,4	7,2	9,1	10,9	12,7	7,3	11,9	15,9	20,1	24,0	28,0
		RGSF/B-2+6	3,7	5,8	7,7	9,6	11,4	13,3	8,2	12,8	17,0	21,2	25,1	29,3
		RGSF/B-2+8	4,1	6,3	8,3	10,2	12,2	14,1	9,0	13,9	18,3	22,5	26,9	31,1
		RGSF/B-4+4	3,7	5,8	7,7	9,6	11,4	13,3	8,2	12,8	17,0	21,2	25,1	29,3
		RGSF/B-4+6	4,1	6,3	8,3	10,2	12,2	14,1	9,0	13,9	18,3	22,5	26,9	31,1
		RGSF/B-4+8	4,5	6,7	8,8	10,9	12,9	15,0	9,9	14,8	19,4	24,0	28,4	33,1
		RGSF/B-6+6	4,5	6,7	8,8	10,9	12,9	15,0	9,9	14,8	19,4	24,0	28,4	33,1
	RGSF/B-6+8	4,9	7,2	9,4	11,6	13,7	15,9	10,8	15,9	20,7	25,6	30,2	35,1	
	RGSF/B-8+8	5,3	7,7	10,0	12,4	14,7	17,0	11,7	17,0	22,0	27,3	32,4	37,5	

# RGSC

RGSC is used in decks and bulkheads which are subjected to higher degrees of stress and heavier loading. The additional, rounded ends help prevent stress cracking. Similar to the RGS frame, it is available in sizes 2, 4, 6 and 8.

RGSC can also be supplied as multiple frames. Available in mild steel, stainless steel and aluminium. Special cornerblocks and STG-endpackings with rounded corners are available.



Endpacking, centre

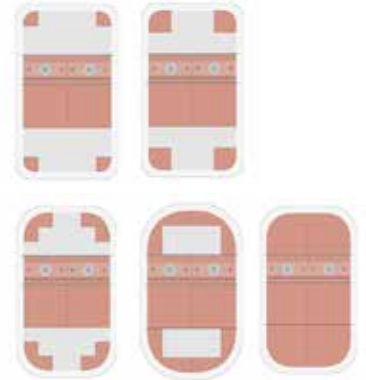

## Corner Blocks

- C20/0 R20
- C30/0 R20
- C40/20x20 R40
- C60/40x40
- C60/0 R40

## RGSC Corner Radius

- Internal Radius: External Radius:
- R20 R30
  - R40 R50
  - R60 R70

Frame size	Size in mm								Size in inches								
	H	x 1	x 2	x 3	x 4	x 5	x 6	x n	H	x 1	x 2	x 3	x 4	x 5	x 6	x n	
RGSC-2	121	140,5	271	401,5	532	662,5	793	W = 130+ 130,5 x n	4.76	5.53	10.67	15.81	20.94	26.08	31.22	W = 0.40 + 5.14 x n	
RGSC-4	179,5	-	-	-	-	-	-		7.07	-	-	-	-	-	-		-
RGSC-6	238	-	-	-	-	-	-		9.37	-	-	-	-	-	-		-
RGSC-8	296,5	-	-	-	-	-	-		11.67	-	-	-	-	-	-		-
RGSC-2+2	242		-	-	-	-	-		9.53		-	-	-	-			
RGSC-2+4	300,5		-	-	-	-	-		11.83		-	-	-	-			
RGSC-2+6	359		-	-	-	-	-		14.13		-	-	-	-			
RGSC-2+8	417,5		-	-	-	-	-		16.44		-	-	-	-			
RGSC-4+4	359		-	-	-	-	-		14.13		-	-	-	-			
RGSC-4+6	417,5		-	-	-	-	-		16.44		-	-	-	-			
RGSC-4+8	476		-	-	-	-	-		18.74		-	-	-	-			
RGSC-6+6	476		-	-	-	-	-		18.74		-	-	-	-			
RGSC-6+8	534,5		-	-	-	-	-		21.04		-	-	-	-			
RGSC-8+8	593		-	-	-	-	-		23.35		-	-	-	-			
RGSC-2+2	232	140,5	n = number of frames wide. Tolerance single frame: Height ± 1 mm Width ± 1 mm Material thickness is 10 mm							9.13	5.53	n = number of frames wide. Tolerance single frame: Height ± 0.04", Width ± 0.01" Material thickness is 0.39".					
RGSC-2+4	290,5	-								11.44	-						
RGSC-2+6	349	-								13.74	-						
RGSC-2+8	407,5	-								16.04	-						
RGSC-4+4	349	-								13.74	-						
RGSC-4+6	407,5	-								16.04	-						
RGSC-4+8	466	-								18.35	-						
RGSC-6+6	466	-								18.35	-						
RGSC-6+8	524,5	-								20.65	-						
RGSC-8+8	583	-		22.95	-												

Endpacking, left (multiple frames)

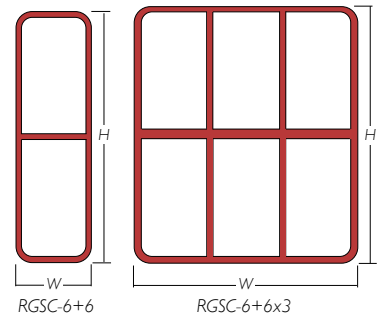
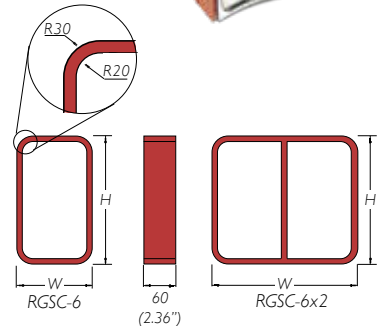
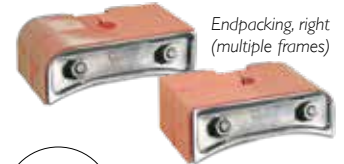

## WEIGHT CHART

Standard frames come in four sizes: 2, 4, 6 and 8. They are all the same width. Height differences are shown below.

The material is 10 mm (0.39") thick.

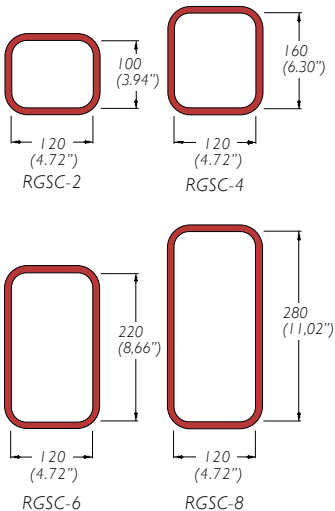

Material	Frame size	Weight in kilograms						Weight in pounds						
		W (width) Multiple Frames						W (width) Multiple Frames						
		x1	x2	x3	x4	x5	x6	x1	x2	x3	x4	x5	x6	
MILD STEEL	RGSC-2	2,2	3,9	5,7	7,4	9,2	10,9	4,9	8,6	12,6	16,3	20,3	24,0	
	RGSC-4	2,7	4,6	6,5	8,4	10,3	12,2	6,0	10,1	14,3	18,5	22,7	26,9	
	RGSC-6	3,2	5,4	7,6	9,8	12,0	14,2	7,1	11,9	16,8	21,6	26,5	31,3	
	RGSC-8	3,8	6,3	8,9	11,4	14,0	16,5	8,4	13,9	19,6	25,1	30,9	36,4	
	S355JR S355J2 S355K2	RGSC-2+2	3,6	8,1	11,9	15,7	19,5	23,3	7,9	17,9	26,2	34,6	43,0	51,4
		RGSC-2+4	4,2	8,8	12,8	16,7	20,7	24,6	9,3	19,4	28,2	36,8	45,6	54,2
		RGSC-2+6	4,8	9,5	13,6	17,8	21,9	26,0	10,6	20,9	30,0	39,2	48,3	57,3
		RGSC-2+8	5,5	10,3	14,7	19,1	23,5	27,9	12,1	22,7	32,4	42,1	51,8	61,5
	A36 AH36 DH36 EH36	RGSC-4+4	4,8	9,5	13,6	17,8	21,9	26,0	10,6	20,9	30,0	39,2	48,3	57,3
		RGSC-4+6	5,5	10,3	14,7	19,1	23,5	27,9	12,1	22,7	32,4	42,1	51,8	61,5
		RGSC-4+8	5,9	11,1	15,8	20,5	25,1	29,8	13,0	24,5	34,8	45,2	55,3	65,7
		RGSC-6+6	5,9	11,1	15,8	20,5	25,1	29,8	13,0	24,5	34,8	45,2	55,3	65,7
	RGSC-6+8	6,5	12,0	17,0	22,1	27,1	32,1	14,3	26,5	37,5	48,7	59,7	70,8	
	RGSC-8+8	7,2	12,9	18,3	23,7	29,1	34,5	15,9	28,4	40,3	52,2	64,2	76,1	
STAINLESS STEEL	RGSC-2	2,2	4,0	5,8	7,6	9,4	11,2	4,9	8,8	12,8	16,8	20,7	24,7	
	RGSC-4	2,8	4,7	6,7	8,6	10,6	12,6	6,2	10,4	14,8	19,0	23,4	27,8	
	RGSC-6	3,3	5,5	7,8	10,0	12,3	14,5	7,3	12,1	17,2	22,0	27,1	32,0	
	RGSC-8	3,9	6,5	9,1	11,7	14,3	16,9	8,6	14,3	20,1	25,8	31,5	37,3	
	I.4404	RGSC-2+2	3,7	8,3	12,2	16,1	20,0	23,9	8,2	18,3	26,9	35,5	44,1	52,7
		RGSC-2+4	4,3	9,0	13,1	17,1	21,2	25,2	9,5	19,8	28,9	37,7	46,7	55,6
		RGSC-2+6	4,9	9,7	14,0	18,2	22,5	26,7	10,8	21,4	30,9	40,1	49,6	58,9
		RGSC-2+8	5,6	10,6	15,1	19,6	24,1	28,6	12,3	23,4	33,3	43,2	53,1	63,1
	AISI 316L	RGSC-4+4	4,9	9,7	14,0	18,2	22,5	26,7	10,8	21,4	30,9	40,1	49,6	58,9
		RGSC-4+6	5,6	10,6	15,1	19,6	24,1	28,6	12,3	23,4	33,3	43,2	53,1	63,1
		RGSC-4+8	6,0	11,4	16,2	21,0	25,8	30,6	13,2	25,1	35,7	46,3	56,9	67,5
		RGSC-6+6	6,0	11,4	16,2	21,0	25,8	30,6	13,2	25,1	35,7	46,3	56,9	67,5
	RGSC-6+8	6,7	12,3	17,5	22,6	27,8	32,9	14,8	27,1	38,6	49,8	61,3	72,5	
	RGSC-8+8	7,4	13,2	18,8	24,3	29,9	35,4	16,3	29,1	41,4	53,6	65,9	78,0	
ALUMINIUM	RGSC-2	0,8	1,4	2,0	2,6	3,2	3,8	1,8	3,1	4,4	5,7	7,1	8,4	
	RGSC-4	1,0	1,6	2,3	3,0	3,6	4,3	2,2	3,5	5,1	6,6	7,9	9,5	
	RGSC-6	1,1	1,9	2,7	3,4	4,2	5,0	2,4	4,2	6,0	7,5	9,3	11,0	
	RGSC-8	1,3	2,2	3,1	4,0	4,9	5,8	2,9	4,9	6,8	8,8	10,8	12,8	
	EN AW-6082 EN AW-5086	RGSC-2+2	1,3	2,8	4,2	5,5	6,9	8,2	2,9	6,2	9,3	12,1	15,2	18,1
		RGSC-2+4	1,5	3,1	4,5	5,9	7,2	8,6	3,3	6,8	9,9	13,0	15,9	19,0
		RGSC-2+6	1,7	3,3	4,8	6,2	7,7	9,1	3,7	7,3	10,6	13,7	17,0	20,1
		RGSC-2+8	1,9	3,6	5,2	6,7	8,3	9,8	4,2	7,9	11,5	14,8	18,3	21,6
		RGSC-4+4	1,7	3,3	4,8	6,2	7,7	9,1	3,7	7,3	10,6	13,7	17,0	20,1
		RGSC-4+6	1,9	3,6	5,2	6,7	8,3	9,8	4,2	7,9	11,5	14,8	18,3	21,6
		RGSC-4+8	2,1	3,9	5,5	7,2	8,8	10,4	4,6	8,6	12,1	15,9	19,4	22,9
		RGSC-6+6	2,1	3,9	5,5	7,2	8,8	10,4	4,6	8,6	12,1	15,9	19,4	22,9
	RGSC-6+8	2,3	4,2	6,0	7,7	9,5	11,2	5,1	9,3	13,2	17,0	20,9	24,7	
	RGSC-8+8	2,5	4,5	6,4	8,3	10,2	12,1	5,5	9,9	14,1	18,3	22,5	26,7	

# RGSK and RGSbtb

RGSK is an extended, standard RGS transit frame, with machined grooves for stayplates and compression plates. The material is 10 mm (0.39") thick on the ends and 12 mm (0.47") thick on the sides. RGSK is available in the four standard sizes: 2, 4, 6 and 8. RGSK frames are recommended if pooling of water on the transit face makes it necessary to install packing blocks at a certain distance from the deck or bulkhead. The frame is 120 mm (4.72") deep (as opposed to 60 mm (2.36") on a RGS) and of standard internal width 120 mm (4.72"). It may be used in multiple frames, see page 17.

RGSbtb is a double transit which is packed from both sides, enabling on site pressure testing of the penetration. Installations with this transit can be pressure tested from the space between the pack block units. This also conform the jet-fire rating. An RGSbtb frame can be used to protect cables from water penetration, combined with EMC protection. One side of the packing takes care of water penetration and the other side gives EMC protection.



The frame is 10 mm (0.39") thick on the ends and 12 mm (0.47") thick on the sides. It is 200 mm (7.87") deep. Other dimensions are the same as for the standard RGS. RGSbtb is available in the four standard sizes: 2, 4, 6, and 8. They may be used in multiple frames.

Frame size	Size in mm							Size in inches						
	H	x 1	x 2	x 3	x 4	x 5	x n	H	x 1	x 2	x 3	x 4	x 5	x n
RGSK/RGSbtb-2	121	144,5	275	405,5	536	666,5	W = 14 + 130,5 x n	4.76	5.69	10.83	15.96	21.10	26.24	W = 0,55" + 5,14 x n
RGSK/RGSbtb-4	179,5	-	-	-	-	-		7.07	-	-	-	-	-	
RGSK/RGSbtb-6	238	-	-	-	-	-		9.37	-	-	-	-	-	
RGSK/RGSbtb-8	296,5	-	-	-	-	-		11.67	-	-	-	-	-	
RGSK/RGSbtb-2+2	232		-	-	-	-		9.13		-	-	-	-	
RGSK/RGSbtb-2+4	290,5		-	-	-	-		11.44		-	-	-	-	
RGSK/RGSbtb-2+6	349		-	-	-	-		13.74		-	-	-	-	
RGSK/RGSbtb-2+8	407,5		-	-	-	-		16.04		-	-	-	-	
RGSK/RGSbtb-4+4	349		-	-	-	-		13.74		-	-	-	-	
RGSK/RGSbtb-4+6	407,5		-	-	-	-		16.04		-	-	-	-	
RGSK/RGSbtb-4+8	466		-	-	-	-		18.35		-	-	-	-	
RGSK/RGSbtb-6+6	466		-	-	-	-		18.35		-	-	-	-	
RGSK/RGSbtb-6+8	524,5		-	-	-	-		20.65		-	-	-	-	
RGSK/RGSbtb-8+8	583		-	-	-	-		22.95		-	-	-	-	

Tolerance single frame:  
Height ± 1 mm, Width ± 1 mm.  
Material thickness is 10 mm.

Tolerance single frame:  
Height ± 0.04", Width ± 0.04"  
Material thickness is 0.39".

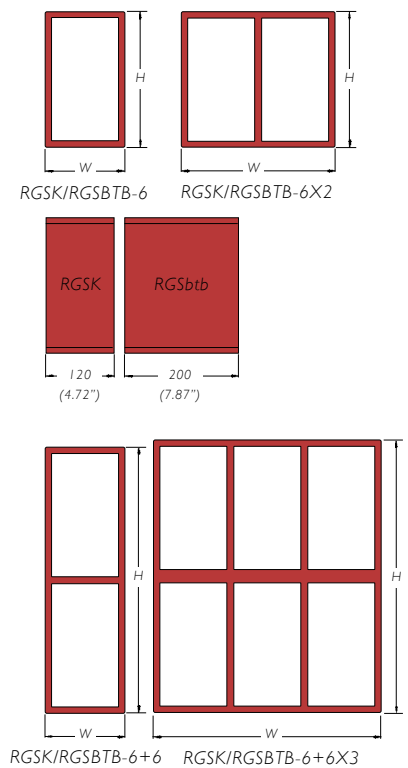



# RGSK

## WEIGHT CHART

Standard frames come in four sizes: 2, 4, 6 and 8. They are all the same width. Height differences are shown below.

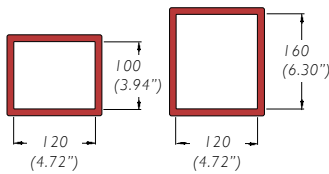

RGSK/RGSBTB-2

RGSK/RGSBTB-4

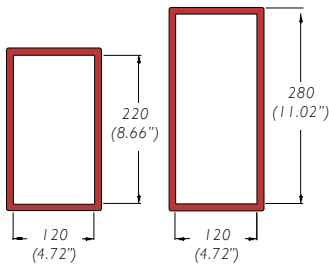

RGSK/RGSBTB-6

RGSK/RGSbtb-8

Material	Frame size	Weight in kilograms						Weight in pounds						
		W (width) Multiple Frames						W (width) Multiple Frames						
		x1	x2	x3	x4	x5	x6	x1	x2	x3	x4	x5	x6	
MILD STEEL	RGSK-2	4,7	7,7	10,7	13,7	16,7	19,7	10,4	17,0	23,6	30,2	36,8	43,4	
	RGSK-4	6,0	9,3	12,6	15,9	19,2	22,5	13,2	20,5	27,8	35,1	42,3	49,6	
	RGSK-6	7,3	10,9	14,5	18,2	21,8	25,4	16,1	24,0	32,0	40,1	48,1	56,0	
	RGSK-8	8,7	12,5	16,4	20,4	24,3	28,2	19,2	27,6	36,2	45,0	53,6	62,2	
	S355JR S355J2 S355K2	RGSK-2+2	7,8	11,9	16,1	20,4	24,6	28,8	17,2	26,2	35,5	45,0	54,2	63,5
		RGSK-2+4	9,2	13,6	18,1	22,6	27,1	31,6	20,3	30,0	39,9	49,8	59,7	69,7
		RGSK-2+6	10,6	15,2	20,0	24,8	29,5	34,3	23,4	33,5	44,1	54,7	65,0	75,6
		RGSK-2+8	11,9	16,9	22,0	27,0	32,1	37,1	26,2	37,3	48,5	59,5	70,8	81,8
	A36 AH36 DH36 EH36	RGSK-4+4	10,6	15,2	20,0	24,8	29,5	34,3	23,4	33,5	44,1	54,7	65,0	75,6
		RGSK-4+6	11,9	16,9	22,0	27,0	32,1	37,1	26,2	37,3	48,5	59,5	70,8	81,8
		RGSK-4+8	13,2	18,4	23,7	29,1	34,4	39,7	29,1	40,6	52,2	64,2	75,8	87,5
		RGSK-6+6	13,2	18,4	23,7	29,1	34,4	39,7	29,1	40,6	52,2	64,2	75,8	87,5
RGSK-6+8		14,5	20,0	25,5	31,0	36,5	42,5	32,0	44,1	56,2	68,3	80,5	93,7	
RGSK-8+8		15,9	21,6	27,4	33,2	38,9	45,2	35,1	47,6	60,4	73,2	85,8	99,6	
STAINLESS STEEL	RGSK-2	4,8	7,9	11,0	14,1	17,1	20,2	10,6	17,4	24,3	31,1	37,7	44,5	
	RGSK-4	6,2	9,5	12,9	16,3	19,7	23,1	13,7	20,9	28,4	35,9	43,4	50,9	
	RGSK-6	7,5	11,2	14,9	18,6	22,3	26,0	16,5	24,7	32,8	41,0	49,2	57,3	
	RGSK-8	8,9	12,8	16,8	20,9	24,9	28,9	19,6	28,2	37,0	46,1	54,9	63,7	
	1.4404	RGSK-2+2	8,0	12,2	16,5	20,9	25,2	29,5	17,6	26,9	36,4	46,1	55,6	65,0
		RGSK-2+4	9,4	13,9	18,5	23,2	27,8	32,4	20,7	30,6	40,8	51,1	61,3	71,4
		RGSK-2+6	10,9	15,6	20,5	25,4	30,3	35,2	24,0	34,4	45,2	56,0	66,8	77,6
	AISI 316L	RGSK-2+8	12,2	17,3	22,5	27,7	32,8	38,0	26,9	38,1	49,6	61,1	72,3	83,8
		RGSK-4+4	10,9	15,6	20,5	25,4	30,3	35,2	24,0	34,4	45,2	56,0	66,8	77,6
		RGSK-4+6	12,2	17,3	22,5	27,7	32,8	38,0	26,9	38,1	49,6	61,1	72,3	83,8
		RGSK-4+8	13,5	18,9	24,4	29,8	35,3	40,7	29,8	41,7	53,8	65,7	77,8	89,7
		RGSK-6+6	13,5	18,9	24,4	29,8	35,3	40,7	29,8	41,7	53,8	65,7	77,8	89,7
RGSK-6+8		14,9	20,5	26,3	32,1	37,8	43,6	32,8	45,2	58,0	70,8	83,3	96,1	
RGSK-8+8	16,3	22,1	28,2	34,2	40,3	46,3	35,9	48,7	62,2	75,4	88,8	102,1		
ALUMINIUM	RGSK-2	1,7	2,7	3,7	4,8	5,8	6,8	3,7	6,0	8,2	10,6	12,8	15,0	
	RGSK-4	2,1	3,3	4,5	5,6	6,8	7,9	4,6	7,3	9,9	12,3	15,0	17,4	
	RGSK-6	2,6	3,8	5,1	6,4	7,6	8,9	5,7	8,4	11,2	14,1	16,8	19,6	
	RGSK-8	3,1	4,4	5,8	7,2	8,5	9,9	6,8	9,7	12,8	15,9	18,7	21,8	
	EN AW-6082 EN AW-5086	RGSK-2+2	2,7	4,2	5,7	7,2	8,6	10,1	6,0	9,3	12,6	15,9	19,0	22,3
		RGSK-2+4	3,2	4,8	6,4	8,0	9,5	11,1	7,1	10,6	14,1	17,6	20,9	24,5
		RGSK-2+6	3,7	5,3	7,0	8,7	10,3	12,0	8,2	11,7	15,4	19,2	22,7	26,5
		RGSK-2+8	4,2	5,9	7,7	9,5	11,2	13,0	9,3	13,0	17,0	20,9	24,7	28,7
		RGSK-4+4	3,7	5,3	7,0	8,7	10,3	12,0	8,2	11,7	15,4	19,2	22,7	26,5
		RGSK-4+6	4,2	5,9	7,7	9,5	11,2	13,0	9,3	13,0	17,0	20,9	24,7	28,7
		RGSK-4+8	4,6	6,4	8,3	10,2	12,0	13,9	10,1	14,1	18,3	22,5	26,5	30,6
		RGSK-6+6	4,6	6,4	8,3	10,2	12,0	13,9	10,1	14,1	18,3	22,5	26,5	30,6
RGSK-6+8		5,1	7,0	9,0	11,0	12,9	14,9	11,2	15,4	19,8	24,3	28,4	32,8	
RGSK-8+8		5,6	7,6	9,7	11,7	13,8	15,8	12,3	16,8	21,4	25,8	30,4	34,8	

# RGSbtb

## WEIGHT CHART

Standard frames come in four sizes: 2, 4, 6 and 8. They are all the same width. Height differences are shown below.

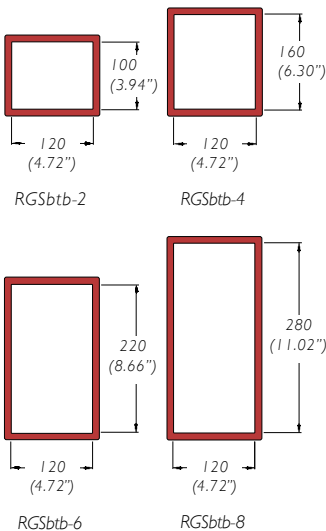

Material	Frame size	Weight in kilograms						Weight in pounds						
		W (width) Multiple Frames						W (width) Multiple Frames						
		x1	x2	x3	x4	x5	x6	x1	x2	x3	x4	x5	x6	
MILD STEEL	RGSbtb-2	7,9	13,0	18,4	23,6	29,1	34,4	17,4	28,7	16,3	52,2	64,2	75,8	
	RGSbtb-4	10,1	15,8	21,7	27,5	33,5	39,4	22,3	34,8	18,5	60,8	73,9	86,9	
	RGSbtb-6	12,4	18,6	25,1	31,4	38,0	44,4	27,3	41,0	21,6	69,4	83,8	97,9	
	RGSbtb-8	14,5	21,2	28,2	35,1	42,2	49,2	32,0	46,7	25,1	77,6	93,0	108,5	
	S355JR S355J2 S355K2	RGSbtb-2+2	13,5	20,9	28,5	36,1	43,7	51,3	29,8	46,1	34,6	79,6	96,3	113,1
		RGSbtb-2+4	15,3	23,3	31,5	39,6	47,8	56,0	33,7	51,4	36,8	87,5	105,4	123,5
		RGSbtb-2+6	17,8	26,3	35,0	43,6	52,4	61,1	39,2	58,0	39,2	96,3	115,5	134,7
		RGSbtb-2+8	20,0	29,1	38,4	47,6	56,9	66,2	44,1	64,2	42,1	105,2	125,4	145,9
	A36 AH36 DH36 EH36	RGSbtb-4+4	17,8	26,3	35,0	43,6	52,4	61,1	39,2	58,0	39,2	96,3	115,5	134,7
		RGSbtb-4+6	20,0	29,1	38,4	47,6	56,9	66,2	44,1	64,2	42,1	105,2	125,4	145,9
RGSbtb-4+8		22,3	31,9	41,7	51,4	61,3	71,1	49,2	70,3	45,2	113,5	135,1	156,7	
RGSbtb-6+6		22,3	31,9	41,7	51,4	61,3	71,1	49,2	70,3	45,2	113,5	135,1	156,7	
RGSbtb-6+8		24,5	34,7	45,1	55,4	65,8	76,2	54,0	76,5	48,7	122,4	145,1	168,0	
RGSbtb-8+8		26,6	37,3	48,2	59,1	70,1	81,0	58,6	82,2	52,2	130,5	154,5	178,6	
STAINLESS STEEL	RGSbtb-2	8,1	13,3	18,8	24,3	29,8	35,3	17,9	29,3	16,8	53,6	65,7	77,8	
	RGSbtb-4	10,4	16,2	22,3	28,2	34,4	40,4	22,9	35,7	19,0	62,4	75,8	89,1	
	RGSbtb-6	12,7	19,1	25,7	32,2	38,9	45,5	28,0	42,1	22,0	71,2	85,8	100,3	
	RGSbtb-8	14,9	21,7	28,9	36,1	43,2	50,4	32,8	47,8	25,8	79,6	95,2	111,1	
	I.4404	RGSbtb-2+2	13,8	21,4	29,2	36,9	44,8	52,6	30,4	47,2	35,5	81,6	98,8	116,0
		RGSbtb-2+4	15,7	23,9	32,3	40,6	49,0	57,4	34,6	52,7	37,7	89,7	108,0	126,5
		RGSbtb-2+6	18,3	27,0	35,9	44,7	53,7	62,6	40,3	59,5	40,1	98,8	118,4	138,0
		RGSbtb-2+8	20,5	29,8	39,3	48,8	58,4	67,9	45,2	65,7	43,2	107,8	128,7	149,7
	AISI 316L	RGSbtb-4+4	18,3	27,0	35,9	44,7	53,7	62,6	40,3	59,5	40,1	98,8	118,4	138,0
		RGSbtb-4+6	20,5	29,8	39,3	48,8	58,4	67,9	45,2	65,7	43,2	107,8	128,7	149,7
RGSbtb-4+8		22,9	32,7	42,8	52,7	62,9	72,9	50,5	72,1	46,3	116,4	138,7	160,7	
RGSbtb-6+6		22,9	32,7	42,8	52,7	62,9	72,9	50,5	72,1	46,3	116,4	138,7	160,7	
RGSbtb-6+8		25,1	35,6	46,1	56,8	67,5	78,1	55,3	78,5	49,8	125,4	148,8	172,2	
RGSbtb-8+8		27,3	38,2	49,4	60,5	71,8	83,0	60,2	84,2	53,6	133,6	158,3	183,0	
ALUMINIUM	RGSbtb-2	2,8	4,6	6,5	8,3	10,2	12,0	6,2	10,1	5,7	18,3	22,5	26,5	
	RGSbtb-4	3,5	5,5	7,6	9,7	11,7	13,8	7,7	12,1	6,6	21,4	25,8	30,4	
	RGSbtb-6	4,3	6,5	8,8	11,0	13,3	15,5	9,5	14,3	7,5	24,3	29,3	34,2	
	RGSbtb-8	5,1	7,4	9,9	12,3	14,8	17,2	11,2	16,3	8,8	27,1	32,6	37,9	
	EN AW-6082 EN-AW-5086	RGSbtb-2+2	4,7	7,3	10,0	12,7	15,3	18,0	10,4	16,1	12,1	28,0	33,7	39,7
		RGSbtb-2+4	5,4	8,2	11,1	13,8	16,8	19,6	11,9	18,1	13,0	30,6	37,0	43,2
		RGSbtb-2+6	6,2	9,2	12,3	15,3	18,4	21,4	13,7	20,3	13,7	33,7	40,6	47,2
		RGSbtb-2+8	7,0	10,2	13,5	16,7	20,0	23,2	15,4	22,5	14,8	36,8	44,1	51,1
		RGSbtb-4+4	6,2	9,2	12,3	15,3	18,4	21,4	13,7	20,3	13,7	33,7	40,6	47,2
		RGSbtb-4+6	7,0	10,2	13,5	16,7	20,0	23,2	15,4	22,5	14,8	36,8	44,1	51,1
	RGSbtb-4+8	7,8	11,2	14,6	18,1	21,5	24,9	17,2	24,7	15,9	39,9	47,4	54,9	
	RGSbtb-6+6	7,8	11,2	14,6	18,1	21,5	24,9	17,2	24,7	15,9	39,9	47,4	54,9	
	RGSbtb-6+8	8,6	12,2	15,8	19,5	23,1	26,7	19,0	26,9	17,0	43,0	50,9	58,9	
	RGSbtb-8+8	9,3	13,1	16,9	20,8	24,6	28,4	20,5	28,9	18,3	45,9	54,2	62,6	

# RGSR

RGSR is used in decks and bulkheads which are subjected to higher degrees of stress and heavier loading. The additional, rounded ends help prevent stress cracking. The radius of the ends is 70 mm (2.76") on otherwise standard 2, 4, 6 and 8 model RGS frames. RGSR can be used in multiple frames. For weight charts and installation details, singularly or in multiple frames, contact MCT Brattberg.



# Multiple Frames



## HORIZONTAL MULTIPLE FRAMES

Horizontal multiple frames are described by listing the frame type and size x the desired number of horizontal openings.

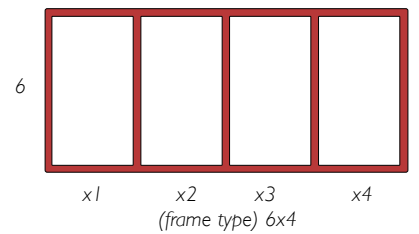

Designation:

## VERTICAL MULTIPLE FRAMES

Vertical multiple frames are described by listing the bottom frame type and size + the next frame type and size.

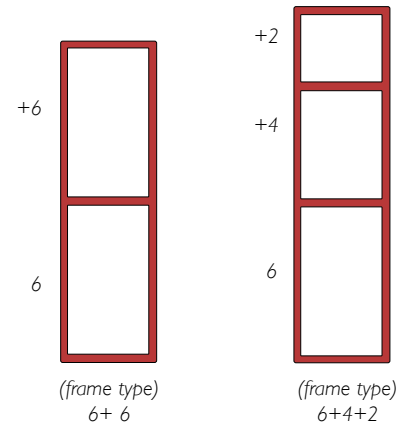

Designation (starting at bottom):

## VERTICAL AND HORIZONTAL MULTIPLE FRAMES

List the entire vertical frames x the desired number of horizontal repetitions.

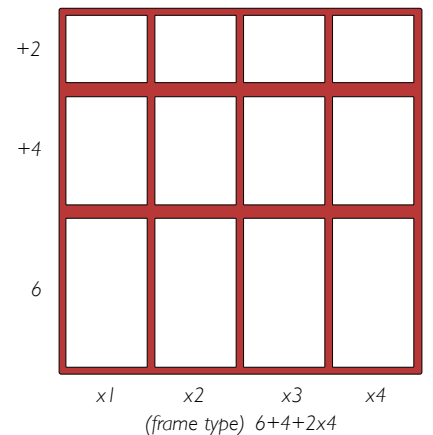

Designation (starting at bottom):

NOTE: All multiple frame designations must be preceded by the frame type.

# RGP-round holes

**RGP** is a Lycron transit frame for assembly in drilled holes, pipes or in MCT Brattberg sleeves (See Installation Guide, page 5 for dimensions of pipes and drilled holes). It is available in eight sizes (see table) and is packed with insert blocks. The metal parts are galvanized or stainless steel.

**RGPO** is a Lycron frame with open sides intended for installation in holes where cables have already been installed. This is also available in seven sizes.



RGP is a circular seal for holes or pipes.



RGPO is an openable RGP frame.

Weight in kilograms		Weight in pounds	
RGP 50	0,25	RGP 2"	0.6
RGP 70	0,4	RGP 3"	0.9
RGP 100	0,7	RGP 4"	1.5
RGP 125	1,0	RGP 5"	2.2
RGP 150	1,8	RGP 6"	4.0
RGP 200	3,0	RGP 8"	6.6
RGP 300	7,5	RGP 11.8"	16.5

Dimensions in mm (inches)		
FRAME SIZE	PACKING AREA	DEPTH AND DIAMETER
RGP 50 (2")		
RGP 70 (3")		
RGP 100 (4")		
RGP 125 (5")		
RGP 150 (6")		
RGP 200 (8")		
RGP 300 (11.8")		

# Sleeves for RGP and RGPO Frame

MCT Brattberg standard sleeves are available in seven sizes, for welding or bolting to the structure.

The standard materials are mild steel, stainless steel and aluminium. SFRB is



SFRBO

SFR

SFRB

S

TYPE S Without flange

TYPE SFR with round flange

TYPE SFRB with round flange and pre drilled holes

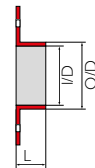
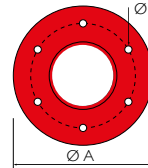
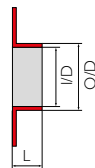
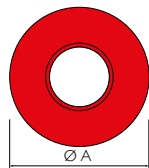
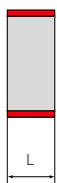
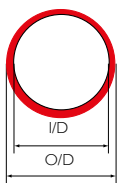

Type S without flange - Below dimensions does not apply to Aluminium, only stainless and mild steel.							
Type/Dimension	O/D mm	L mm	Weight kg	Type/Dimension	O/D inch	L inch	Weight lbs
S 50	63	82	0,7	2"	2.5	3.2	1.4
S 70	83	82	0,8	S-3	3.52	3.2	1.8
S 100	114	82	1,3	S-4	4.55	3.2	1.8
S 125	139	82	1,6	S-5	5.55	3.2	1.8
S 150	164	82	1,9	S-6	6.55	3.2	1.8
S 200	214	82	2,6	S-8	8.55	3.2	1.8
S 300	316	82	4,5	S-11.8	12.44	3.2	9.9

Dimensions for pipes and drilled holes see page 31

Dimensions for pipes and drilled holes see page 31

Sleeves can also be supplied to US Standard Diameters.

Type SFR and SFRB with round flange - Type S without flange - Below dimensions does not apply to Aluminium, only stainless and mild steel.													
Type/Dimension	O/D mm	L mm	A mm	E mm	Weight kg	Qty of holes	Type/Dimension	O/D inch	L inch	A inch	E inch	Weight lbs	Qty of holes
SFR/SFRB 50	63	86	145	9	1,4	4	SFR/SFRB 2"	2.48	3.4	6	0.35	2.8	4
SFR/SFRB 70	83	86	185	9	2,1	4	SFR/SFRB 3"	3.27	3.4	7.5	0.35	4.6	4
SFR/SFRB 100	114	86	215	9	2,9	4	SFR/SFRB 4"	4.49	3.4	8.5	0.35	6.4	4
SFR/SFRB 125	140	86	240	9	3,7	4	SFR/SFRB 5"	5.51	3.4	9.5	0.35	8.2	4
SFR/SFRB 150	164	86	264	11	4,2	6	SFR/SFRB 6"	6.46	3.4	10.5	0.43	9.3	6
SFR/SFRB 200	214	86	315	11	5,1	6	SFR/SFRB 8"	8.43	3.4	12.5	0.43	11.2	6
SFR/SFRB 300	316	86	398	11	8,5	10	SFR/SFRB 11.8"	12.44	3.4	15.7	0.43	18.7	10

Dimensions for pipes and drilled holes see page 31

Dimensions for pipes and drilled holes see page 31

# Components

## PTG-PRESSWEDGE

Can be used as an alternative to compression plate and STG. Can also be placed anywhere in the frame. Made of Lycron, with stainless steel fittings.

Must always be installed in combination with a stayplate.

PTG Allen

PTG Hex

PTG Allen 60

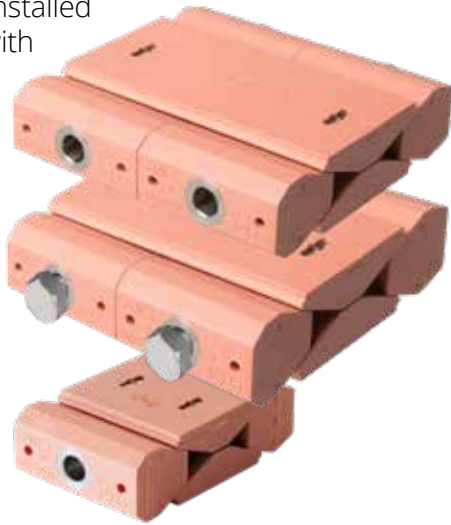

## STAYPLATE

To be placed between each row of blocks.

Stayplates simplifies installation, increases stability and anchors blocks within the frame. Plates come in galvanized or stainless steel and aluminium.

Stayplate

Stayplate 60



## STG-ENDPACKING

Installed between compression plate and the top of the frame, completing the seal. Made of Lycron with galvanized or stainless steel fittings.



## COMPRESSION PLATE

Usually assembled above top row of blocks. The plate bolt is tightened to compress blocks around cables, while providing room for STG endpacking. Comes in GRP, glassfibre reinforced polyester.

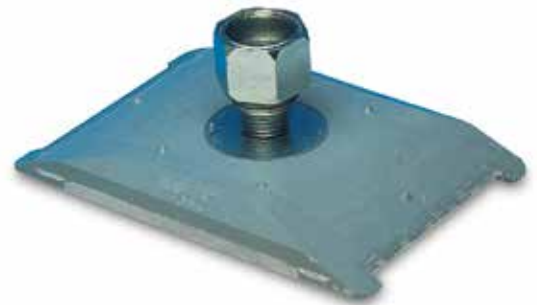

## LUBRICANT

30 g / 25 ml (0.07 pound / 0.85 oz)

For easier installation and must be used with pressure-tight installation,



Component	Weight in kilograms	Weight in pounds
Compression Plate	0.24	0.53
STG	0.6	1.32
PTG 120 Hex and Allen	0.83	1.81
PTG 60 Hex and Allen	0.41	0.9
Stayplate	0.13	0.29
Stayplate 60	0.02	0.04

# Accessories

## SPACER TOOL

Simplifies insertion of last row of blocks.  
20, 30, 40 mm (0.79", 1.18", 1.57")

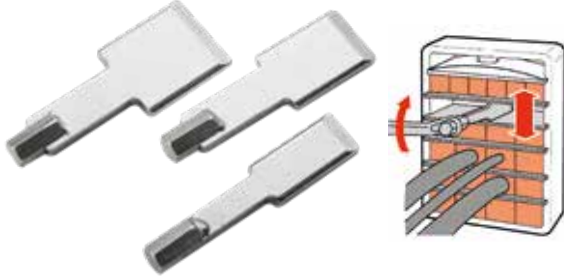

## BLOCK SELECTOR

For cable/pipe measurement.

STD insert



AddBlock



HandiBlock



## RING SPANNER

For end packer & RGP installation.



## CABLE SEPARATOR

Support cables during installation.



## PACKING TOOL

Compresses insert block to hold cable/pipes during partial installations.



## END PACKER PULLER

For re-entry into system.



## QUICK RELEASE SPANNER

For Compression Plate Installation.



## BLANKING PLATE

Seals frame prior to block installation.

Ingress protection IP65/66



# Planning the Packing Space

The space in a frame, which can be used exclusively for holding Insert Blocks, is called the packing space. In the RGS-type frames the compression system always occupies 40 mm (1.57") of each frame.

In the RGP frames no compression system or stayplates are necessary. Therefore the packing space consists of the entire interior area of the frame.

Tables to help you determine which Insert Block to use are on pages 27 (the standard Blocks) 28 (AddBlocks) and 30 (HandiBlocks).

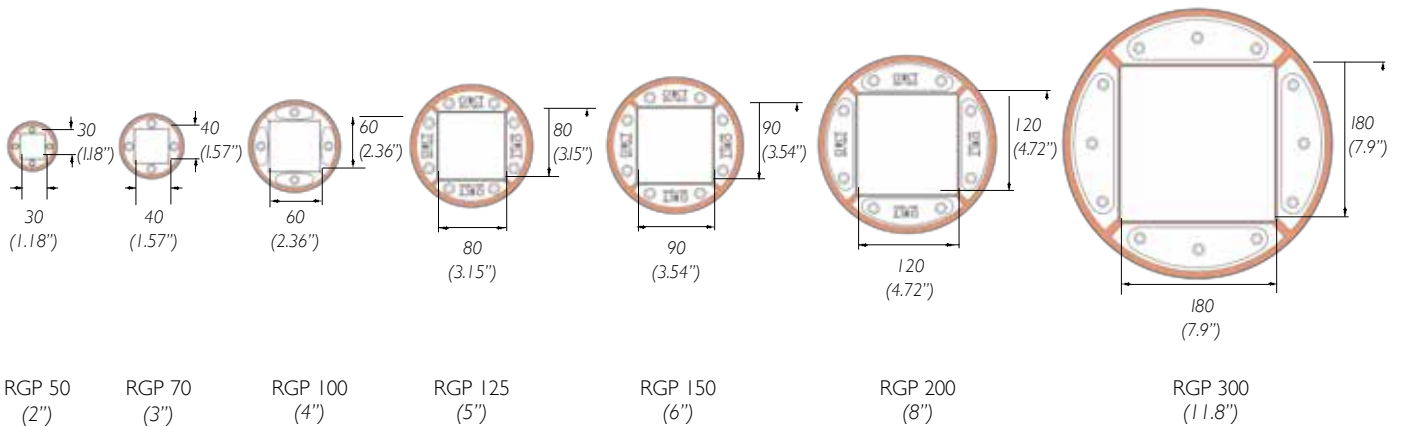
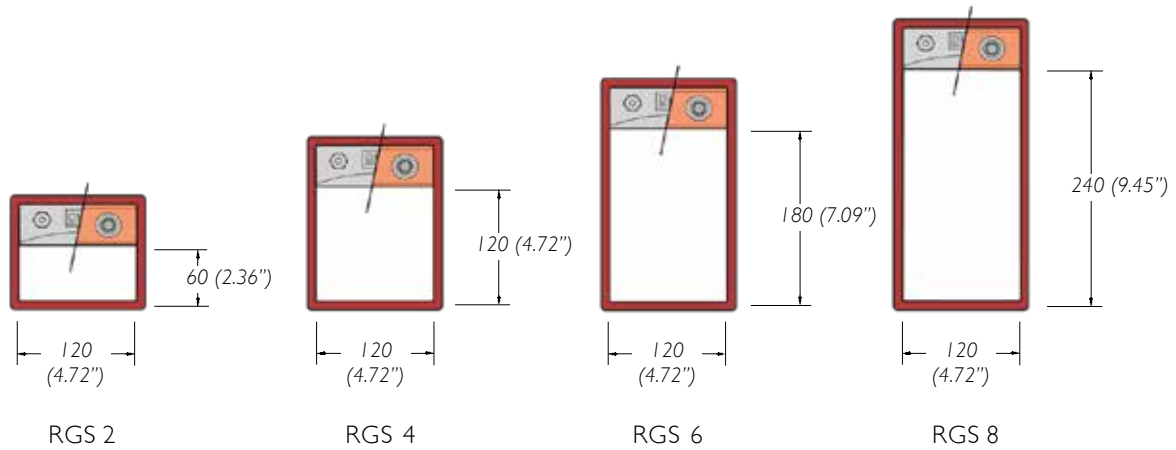



RGS maximum number of cables and pipes							
	Block sizes						
	15	20	30	40	60	90	120
Frame sizes	Maximum number of cables and pipes						
RGS 2	32	18	8	3	2	-	-
RGS 4	64	36	16	9	4	1	1
RGS 6	96	54	24	12	6	2	1
RGS 8	128	72	32	18	8	2	2

RGP maximum number of cables and pipes							
	Block sizes						
	15	20	30	40	60	90	120
Frame sizes	Maximum number of cables and pipes						
RGP 50 RGP (2")	4	1	1	-	-	-	-
RGP 70 RGP (3")	4	4	1	1	-	-	-
RGP 100 RGP (4")	16	9	4	1	1	-	-
RGP 125 RGP (5")	25	16	4	1	1	-	-
RGP 150 RGP (6")	36	16	9	4	1	1	-
RGP 200 RGP (8")	64	36	16	9	4	1	1

A couple of examples of pack plans are shown here above. RGS to the left and RGP to the right. The largest cables are placed at the bottom.

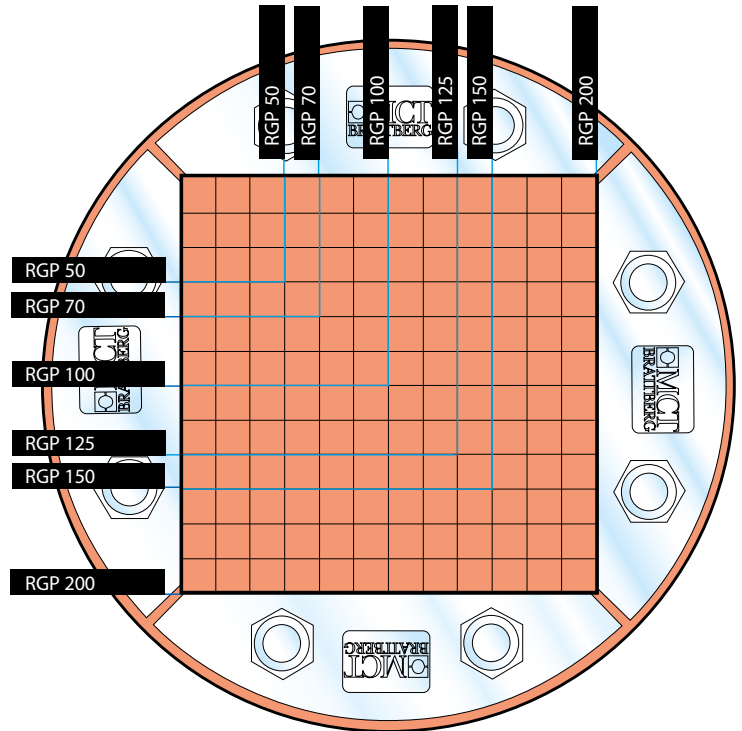
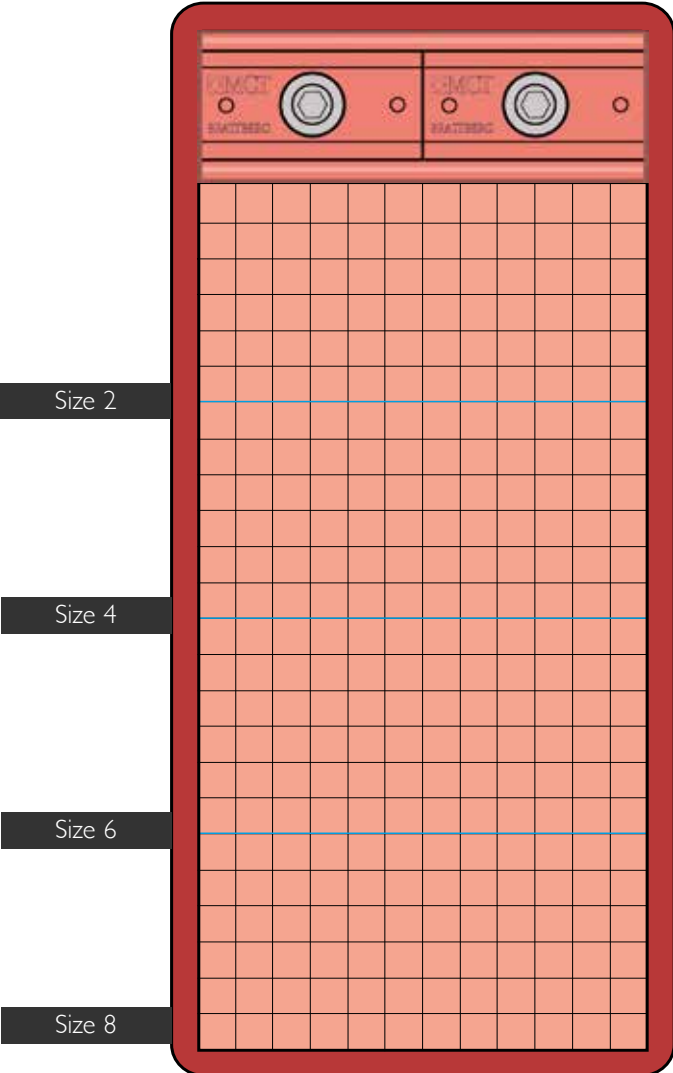

Combination frame width compared with width of cable tray						
Cable type		Cable tray width in mm/inches				
		150/6"	200/8"	300/12"	400/16"	600/24"
Signal	Frame size	6	6x2	6x3	6x4	6x5
Power		4	4x2	4x3	4x4	4x5
Combination		6	6x2	6x3	6x4	6x5

# Packing Plan

## RGS, RGSF, RGSK, RGSR AND RGSbtb

The correct frame size can be determined by using this plan. The notes to the right side of the plan represent the available packing space for frame size 2, 4, 6 and 8.

It is not necessary to show stay plates, compression plates or endpackings since sufficient space for these is already reserved in the tables.

The notes to the left side of the plan represent the available packing space for the different RGP frames.

Dimensions of Standard Insert Blocks, AddBlocks, Plugs, HandiBlock and U-blocks, see pages 26-31.



Blocks

---



---



---



---



---

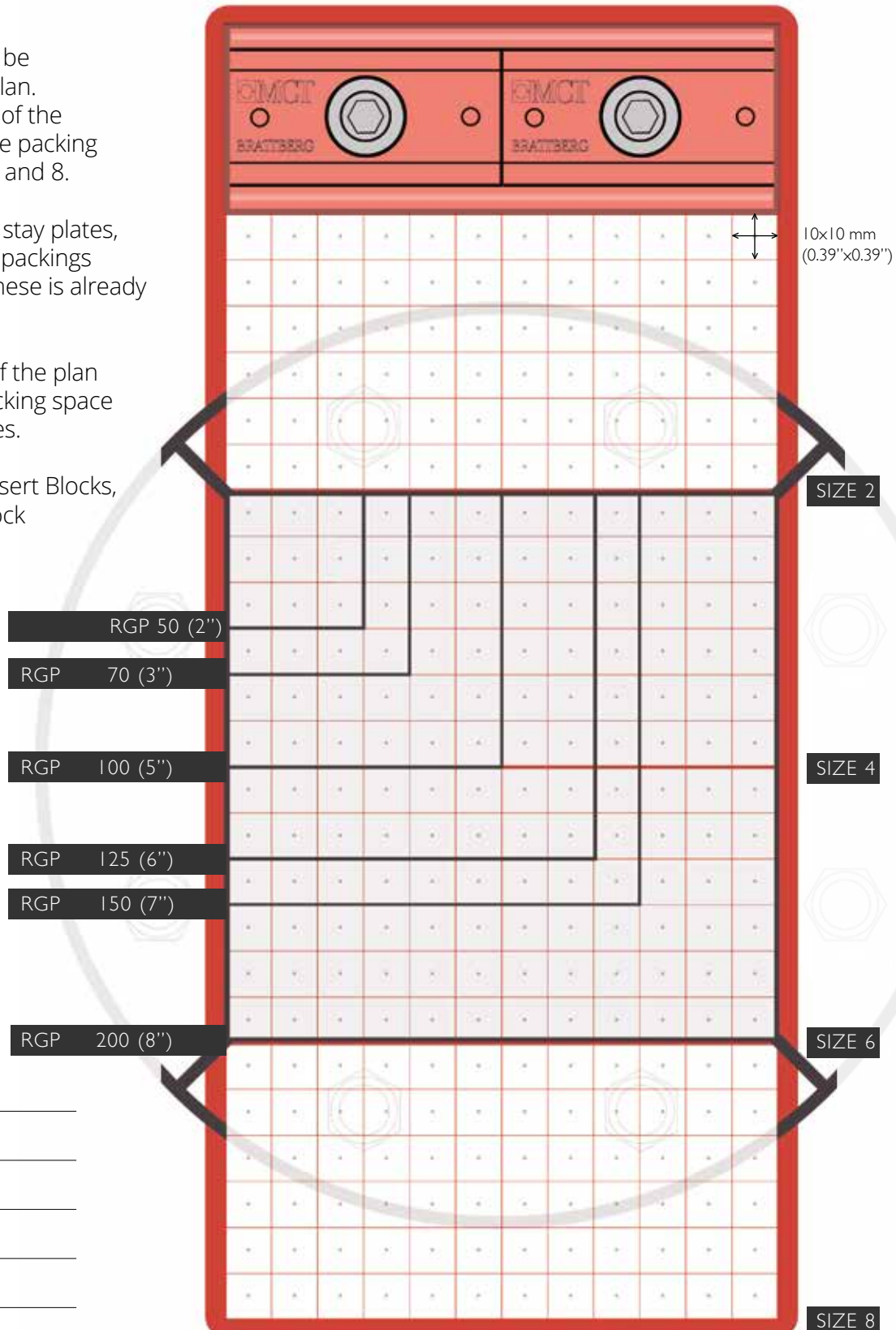

# RGPlan

## WEB-BASED DESIGN SOFTWARE

Configure cable/pipe penetrations quickly and easily with our Web-based design software. It's faster and simpler than time-consuming manual methods. It's perfect solution for busy engineers/designers.

It's free and completely web based. Log in to access your projects anywhere. You can share projects with team members to allow them to edit and configure the transits. Built with smart functions, to help reduce your transit planning time. Simply input the transit requirements and RGPlan automatically configures the seal, along with all necessary components, Insert Blocks, stayplates and compression systems – at the touch of a button. The program now offers many unique editing features, multiple transit calculation and a simple format to deliver well designed MCT Brattberg transits.

Web-based design software gives a lot of opportunities, including following:

- Create a favorite list of your most used cables for easy access.
- Import new cables from Excel buy using a cable list template.
- Categorize and highlight placed cables for easy overview, for example to separate high voltage cables and sensitive data cables.
- Add team members to a project to allow them to edit and configure the transits within the project.
- Every progress you make is autosaved in realtime.
- Download project reports, Bom:s and drawings at any time.

Web-based design software  
The service is free of charge and no download is required. [rgplan.mctbrattberg.com](http://rgplan.mctbrattberg.com)

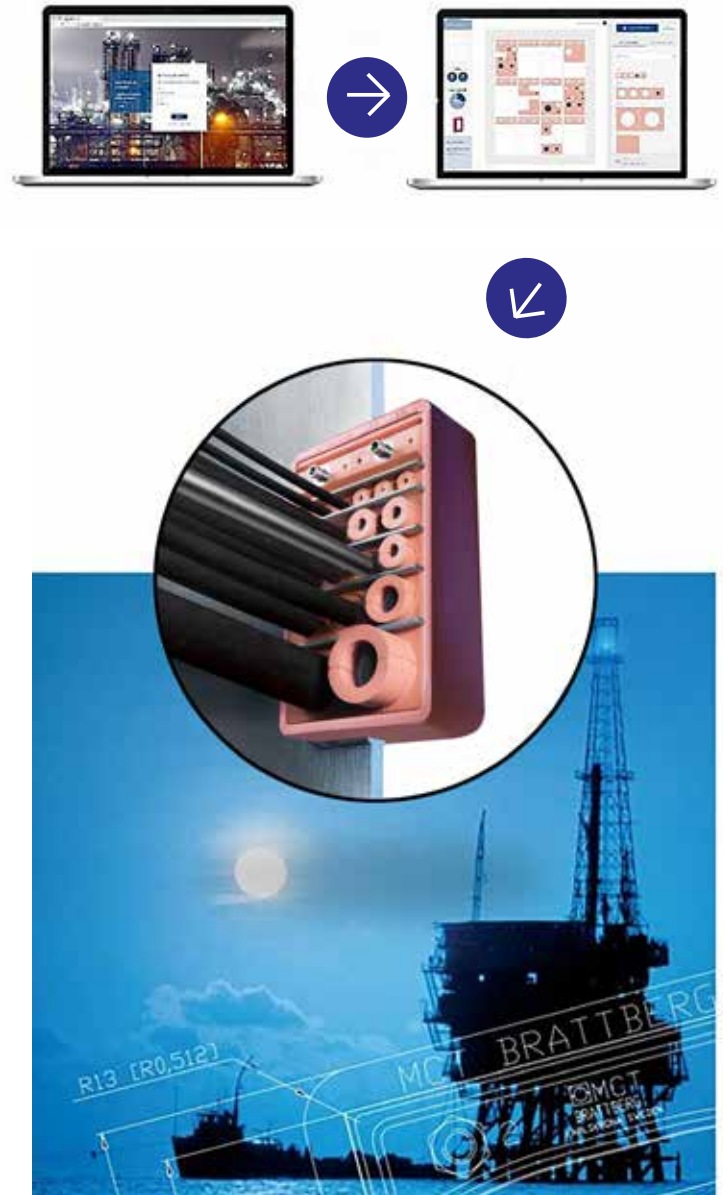

# Standard Blocks

Our range of blocks accommodates cables between 3,5 - 101,5 mm (0.14- 4.0") in diameter. It is important that the insert block is the right size, with respect to the cable, to ensure a proper seal.

Measure the cable diameters carefully and choose insert blocks accordingly. With the sizing chart on next page you can choose the correct size of insert blocks.

Blocks are referred to by their width (A) and hole diameter (B). Thus a block with a width of 15 mm (0.59") and a hole diameter of 4 mm (0.16") is referred to as 15/4. This designation is moulded into the block.

Certain markets denote Insert Blocks in pairs. Please consult MCT Brattberg for this information.

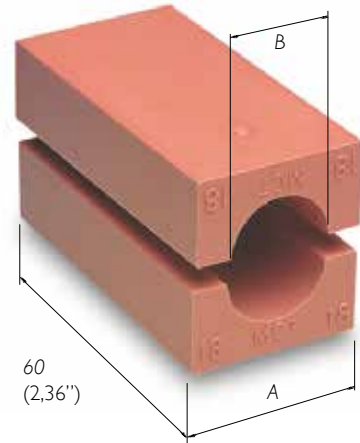

# SpareBlocks

Spare room in each frame is filled out with solid insert blocks. Called spares, they bear the designation A/0. Blocks are referred to by their width (A), followed by the designation /0 (indicating solid). Thus a block with a width and height of 15 mm (0.59") is referred to as 15/0. The length of insert blocks is always 60 mm (2.36")

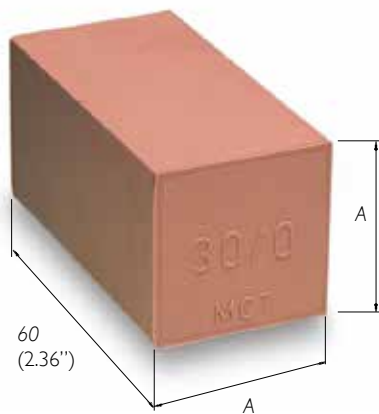

Block size in mm Width (A) = Height (A)	Size in inches	BLOCK DESIGNATION
5 x 5 Only in strips of 24 pcs	0.20" x 0.20" Only in strips of 24 pcs	24x5/0
10 x 10 Only in strips of 12 pcs	0.39" x 0.39" Only in strips of 12 pcs	12x10/0
15 x 15	0.59" x 0.59"	15/0
20 x 20	0.79" x 0.79"	20/0
30 x 30	1.18" x 1.18"	30/0
40 x 40	1.58" x 1.58"	40/0
60 x 60	2.36" x 2.36"	60/0
90 x 30	3.54" x 1.18"	90x30/0

CABLE DIAM.	A (mm)				B
	15	20	30	40	
3.5-4.5	15/4	20/4			4
4.5-5.5	15/5	20/5			5
5.5-6.5	15/6	20/6			6
6.5-7.5	15/7	20/7			7
7.5-8.5	15/8	20/8			8
8.5-9.5	15/9	20/9			9
9.5-10.5		20/10			10
10.5-11.5		20/11			11
11.5-12.5		20/12	30/12		12
12.5-13.5		20/13	30/13		13
13.5-14.5		20/14	30/14		14
14.5-15.5			30/15		15
15.5-16.5			30/16		16
16.5-17.5			30/17		17
17.5-18.5			30/18		18
18.5-19.5			30/19		19
19.5-20.5			30/20		20
20.5-21.5			30/21		21
21.5-22.5			30/22	40/22	22
22.5-23.5			30/23	40/22	23
23.5-24.5			30/24	40/24	24
23.5-25.5				40/24	24

CABLE DIAM.	A (mm)			B
	40	60	90	
25.5-27.5	40/26			26
27.5-29.5	40/28			28
29.5-31.5	40/30			30
31.5-33.5	40/32	60/32		32
33.5-35.5	40/34	60/34		34
35.5-37.5		60/36		36
37.5-39.5		60/38		38
39.5-41.5		60/40		40
41.5-43.5		60/42		42
43.5-45.5		60/44		44
45.5-47.5		60/46		46
47.5-49.5		60/48		48
49.5-51.5		60/50	90/50	50
51.5-53.5		60/52	90/52	52
53.5-55.5		60/54	90/54	54
53.5-55.5	80/54			54
55.5-57.5	80/56			56
57.5-59.5	80/58			58
59.5-61.5	80/60			60
61.5-63.5	80/62			62
63.5-65.5	80/64			64
65.5-67.5	80/66			66
67.5-69.5	80/68			68
69.5-71.5	80/70			70

CABLE DIAM.	A (mm)		B
	90	120	
55.5-57.5	90/56		56
57.5-59.5	90/58		58
59.5-61.5	90/60		60
61.5-63.5	90/62		62
63.5-65.5	90/64		64
65.5-67.5	90/66		66
67.5-69.5	90/68		68
69.5-71.5	90/70		70
71.5-73.5		120/72	72
73.5-75.5		120/74	74
75.5-77.5		120/76	76
77.5-79.5		120/78	78
79.5-81.5		120/80	80
81.5-83.5		120/82	82
83.5-85.5		120/84	84
85.5-87.5		120/86	86
87.5-89.5		120/88	88
89.5-91.5		120/90	90
91.5-93.5		120/92	92
93.5-95.5		120/94	94
95.5-97.5		120/96	96
97.5-99.5		120/98	98
99.5-101.5		120/100	100

Blocks are referred to by their width (A) and hole diameter (B). Thus a module with a width of 15 mm and a hole diameter of 4 mm is referred to as 15/4.

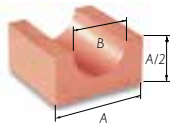

CABLE DIAM.	A (inches)				B
	0.59	0.79	1.18	1.58	
0.14-0.18	15/4	20/4			0.16
0.18-0.22	15/5	20/5			0.20
0.22-0.26	15/6	20/6			0.24
0.26-0.30	15/7	20/7			0.28
0.30-0.33	15/8	20/8			0.31
0.33-0.37	15/9	20/9			0.35
0.37-0.41		20/10			0.39
0.41-0.45		20/11			0.43
0.45-0.49		20/12	30/12		0.47
0.49-0.53		20/13	30/13		0.51
0.53-0.57		20/14	30/14		0.55
0.57-0.61			30/15		0.59
0.61-0.65			30/16		0.63
0.65-0.69			30/17		0.67
0.69-0.73			30/18		0.71
0.73-0.77			30/19		0.75
0.77-0.81			30/20		0.79
0.81-0.85			30/21		0.83
0.85-0.89			30/22	40/22	0.87
0.89-0.93			30/23	40/22	0.91
0.93-1.00			30/24	40/24	0.95

Blocks are referred to by their width (A) and hole diameter (B). Thus a module with a width of 0.59" and a hole diameter of 0.16" is referred to as 15/4.

CABLE DIAM.	A (inches)			B
	1.58	2.36	3.55	
1.00-1.10	40/26			1.02
1.10-1.16	40/28			1.10
1.16-1.24	40/30			1.18
1.24-1.32	40/32	60/32		1.26
1.32-1.40	40/34	60/34		1.34
1.40-1.48		60/36		1.42
1.48-1.55		60/38		1.50
1.55-1.63		60/40		1.58
1.63-1.71		60/42		1.65
1.71-1.79		60/44		1.73
1.79-1.87		60/46		1.81
1.87-1.95		60/48		1.89
1.95-2.03		60/50	90/50	1.97
2.03-2.11		60/52	90/52	2.05
2.11-2.18		60/54	90/54	2.13

CABLE DIAM.	A (inches)		B
	3.55	4.73	
2.18-2.26	90/56		2.21
2.26-2.34	90/58		2.29
2.34-2.42	90/60		2.36
2.42-2.50	90/62		2.44
2.50-2.58	90/64		2.52
2.58-2.66	90/66		2.60
2.66-2.74	90/68		2.68
2.74-2.81	90/70		2.76
2.81-2.89		120/72	2.84
2.89-2.97		120/74	2.92
2.97-3.05		120/76	2.99
3.05-3.13		120/78	3.07
3.13-3.21		120/80	3.15
3.21-3.29		120/82	3.23
3.29-3.36		120/84	3.31
3.36-3.44		120/86	3.39
3.44-3.52		120/88	3.47
3.52-3.60		120/90	3.55
3.60-3.68		120/92	3.62
3.68-3.76		120/94	3.70
3.76-3.84		120/96	3.78
3.84-3.92		120/98	3.86
3.92-3.99		120/100	3.94

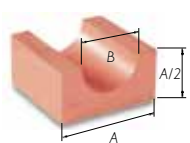

Weight in grams per half							
BLOCK	W	BLOCK	W	BLOCK	W	BLOCK	W
24 x 5/0	58	20/11	13	40/30	42	90/62	239
12 x 10/0	113	20/12	13	40/32	37	90/64	229
15/0	20	20/13	12	40/34	32	90/66	220
20/0	38	20/14	11	60/32	131	90/68	211
30/0	84	30/12	36	60/34	127	90/70	204
40/0	150	30/13	36	60/36	122	120/72	494
60/0	338	30/14	35	60/38	116	120/74	485
90x30/0	279	30/15	34	60/40	110	120/76	472
15/4	10	30/16	33	60/42	104	120/78	462
15/5	10	30/17	31	60/44	98	120/80	448
15/6	10	30/18	30	60/46	91	120/82	437
15/7	10	30/19	28	60/48	84	120/84	425
15/8	9	30/20	27	60/50	77	120/86	415
15/9	8	30/21	25	60/52	59	120/88	403
20/4	18	30/22	24	60/54	61	120/90	385
20/5	18	30/23	22	90/50	287	120/92	368
20/6	17	30/24	21	90/52	279	120/94	360
20/7	17	40/22	57	90/54	273	120/96	351
20/8	16	40/24	54	90/56	262	120/98	332
20/9	15	40/26	50	90/58	255	120/100	313
20/10	14	40/28	47	90/60	243	120/108	243

Weight in oz per half							
BLOCK	W	BLOCK	W	BLOCK	W	BLOCK	W
24 x 5/0	2.0	20/11	0.5	40/30	1.5	90/62	8.4
12 x 10/0	4.0	20/12	0.5	40/32	1.3	90/64	8.1
15/0	0.7	20/13	0.4	40/34	1.1	90/66	7.7
20/0	1.3	20/14	0.4	60/32	4.7	90/68	7.4
30/0	3.0	30/12	1.3	60/34	4.5	90/70	7.2
40/0	5.3	30/13	1.3	60/36	4.3	120/72	17.4
60/0	11.9	30/14	1.2	60/38	4.1	120/74	17.1
90x30/0	9.8	30/15	1.2	60/40	3.9	120/76	16.6
15/4	0.4	30/16	1.2	60/42	3.7	120/78	16.3
15/5	0.4	30/17	1.1	60/44	3.5	120/80	15.8
15/6	0.4	30/18	1.0	60/46	3.2	120/82	15.4
15/7	0.4	30/19	1.0	60/48	3.0	120/84	15.0
15/8	0.3	30/20	1.0	60/50	2.7	120/86	14.6
15/9	0.3	30/21	0.9	60/52	2.4	120/88	14.2
20/4	0.6	30/22	0.8	60/54	2.2	120/90	13.6
20/5	0.6	30/23	0.8	90/50	10.1	120/92	13.0
20/6	0.6	30/24	0.7	90/52	9.8	120/94	12.7
20/7	0.6	40/22	2.0	90/54	9.6	120/96	12.3
20/8	0.6	40/24	1.9	90/56	9.2	120/98	11.7
20/9	0.5	40/26	1.8	90/58	9.0	120/100	11.0
20/10	0.5	40/28	1.7	90/60	8.6	120/108	8.6

# AddBlock

There are eleven different sizes of AddBlock. By tearing off the wing-like inserts, which are of varying thickness, and inserting them in the main block it is possible to accommodate 66 different cable and pipe dimensions, from 3.5 mm (0.14") to 69.5 mm (2.74"). The inserts are fitted with a locating ridge that fits exactly into furrows in the main block. These stop the block from "telescoping".

A seal using AddBlocks is as secure and tight as one using standard blocks. Both types can be combined in a transit, which makes the MCT Brattberg seal system very flexible.

*The AddBlocks basic dimension is given at bottom slot center, and that's the maximum cable dimension the block is designed for.*

*Dimensions are also clearly marked on the four insert sheets. Simply select, tear off and insert.*

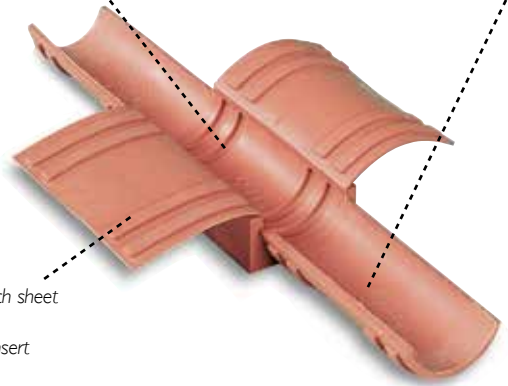

*On the bottom of each sheet you'll find four locking devices to keep the insert in place, making each AddBlock thoroughly secure.*

## Eleven blocks and 66 dimensions

AddBlocks are all the same length as standard Blocks, 60 mm (2.36"). The width of standard Blocks (A measurement, see table) are 20, 30, 40, 60 or 90 mm,

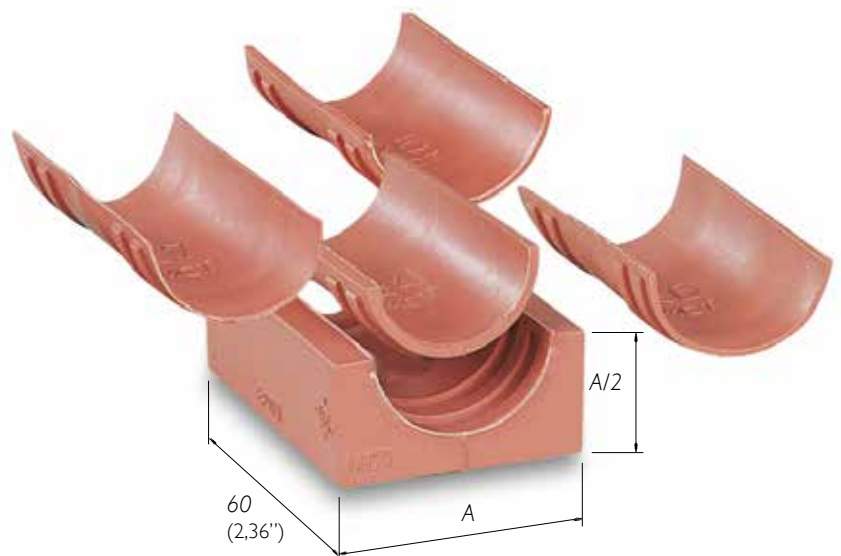



ADDBLOCK DIMENSION	CABLE OR PIPE DIMENSION (mm)	WEIGHT PER HALF (G)	CABLE OR PIPE DIMENSION (inches)	WEIGHT PER HALF (oz)
20/4 - 8	3,5 - 8,5	23	0.14 - 0.33	0.8
20/9 - 13	8,5 - 13,5	23	0.33 - 0.53	0.8
30/14 - 18	13,5 - 18,5	45	0.53 - 0.72	1.6
30/19 - 23	18,5 - 23,5	43	0.72 - 0.93	1.5
40/24 - 28	23,5 - 28,5	71	0.93 - 1.12	2.5
40/29 - 33	28,5 - 33,5	62	1.12 - 1.32	2.2
60/34 - 38	33,5 - 38,5	150	1.32 - 1.52	5.3
60/39 - 43	38,5 - 43,5	136	1.52 - 1.71	4.8
60/44 - 48	43,5 - 49,5	128	1.71 - 1.95	4.5
90/50 - 58	49,5 - 59,5	348	1.95 - 2.34	12.3
90/60 - 68	59,5 - 69,5	318	2.34 - 2.74	11.2

# Plugs and Wraps

The plug's main purpose is to prepare coming installations by creating a spare block together with an AddBlock. Once the cable penetration is to be done, the plug is removed and the AddBlock is reused.

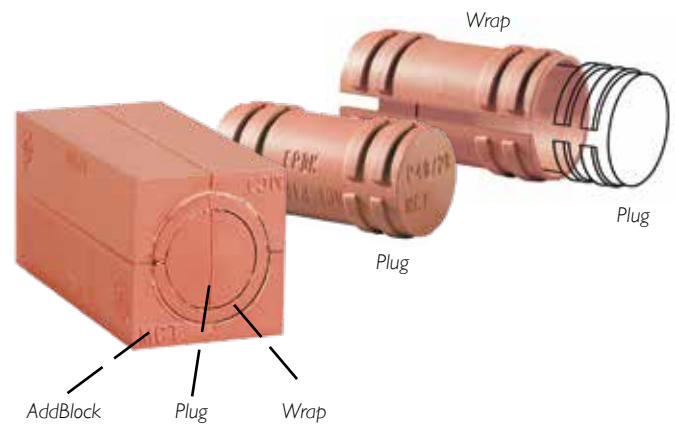

In the table you see which plug, or combination of plug and wrap-around casing, to use when turning an AddBlock into a spare block.

ADDBLOCK	PLUG	WRAP
20/4 - 8	P20/8	
20/9 - 13	P20/8 +	W20/8-13
30/14 - 18	P30/18	
30/19 - 23	P30/18 +	W30/18-23
40/24 - 28	P40-28	
40/29 - 33	P40-28 +	W40/28-33
60/34 - 38	P60/38	
60/39 - 43	P60/38 +	W60/38-43
60/44 - 48	P60/38 +	W60/38-43 and W60/43-48

# HandiBlock

The HandiBlock is designed to facilitate installation and minimize errors, allowing correction of errors and consequently minimization of wastage.

With HandiBlock the transit can always be pre-packed. If a cable or pipe is missing during assembly, the block is quickly rebuilt with a HandiPlug to a closed block and the transit can be completed at a later time.

HandiBlock is available in four sizes to fit cables and pipes or tubing from Ø 4 to 54 mm (Ø 1.58" to 2.13"). A HandiBlock consists of two compact MainBlocks with grooves on the inside and two inserts consisting of many compressed rings in different sizes. Each ring has clear markings for different cable sizes. It helps the technician to quickly and safely choose the right size of block, insert and ring. HandiBlock's design creates a seal as in compression do not deform the parts of the block. This means that all parts can be reused when repacking.

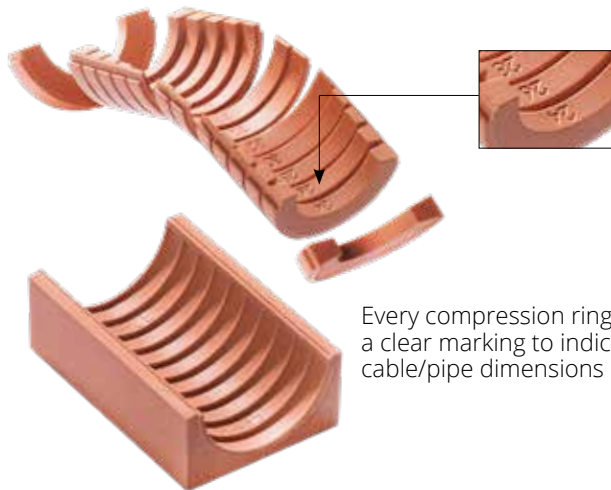
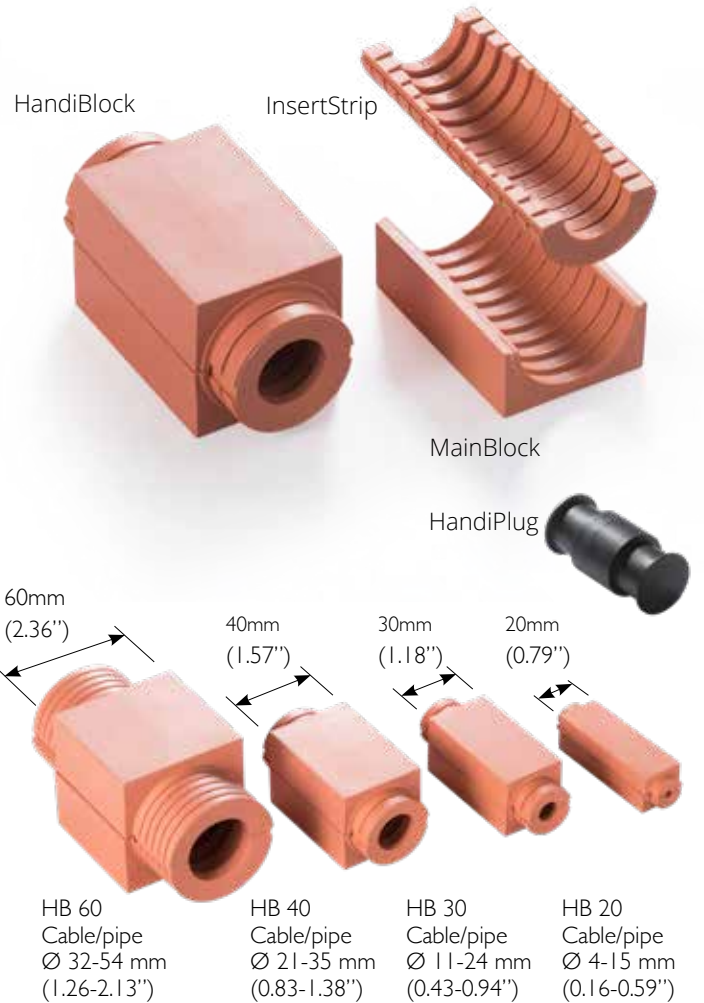

Every compression ring has a clear marking to indicate different cable/pipe dimensions

Extra fire protection! The part of the InsertStrip that protrudes from the MainBlock, acts as a small but effective heat shield.



Size		HandiBlock complete with Plug		HandiBlock without Plug		Plug		Mainblock		Insert Strip	
mm	(inches)	gram	(Oz)	gram	(Oz)	gram	(Oz)	gram	(Oz)	gram	(Oz)
20	0.79	37	1.31	32	1.13	5	0.18	22	0.78	10	0.35
30	1.18	90	3.17	73	2.57	17	0.60	46	1.62	27	0.95
40	1.57	150	5.29	117	4.13	33	1.16	72	2.54	44	1.55
60	2.36	382	13.58	300	10.58	85	3.00	155	5.47	144	5.08



# U-Blocks

The U-Block is used to convert the external dimensions of InsertBlocks, AddBlocks and HandiBlocks to the next modular size.

For example a 30/15 InsertBlock can be enlarged by placing it into a U40, giving the new size of 40/15.

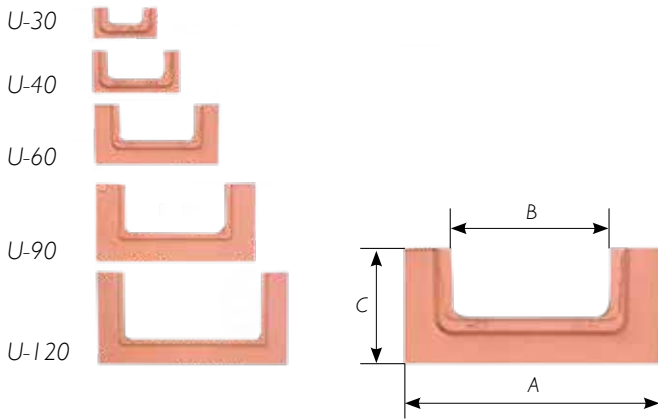
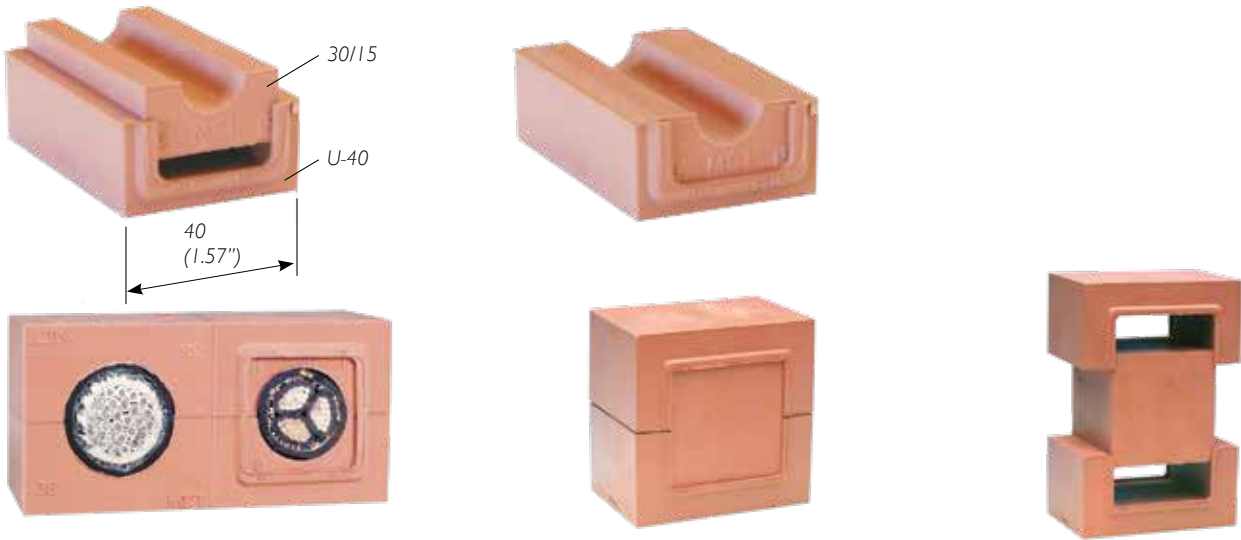

Dimensions U-BLOCK	A		B		C		Weight
	mm	(inches)	mm	(inches)	mm	(inches)	Gram/pair
U-30	30	1.18	20	0.79	15	0.59	46
U-40	40	1.57	30	1.18	20	0.79	64
U-60	60	2.36	40	1.57	30	1.18	186
U-90	90	3.54	60	2.36	45	1.77	416
U-120	120	4.72	90	3.54	60	2.36	584

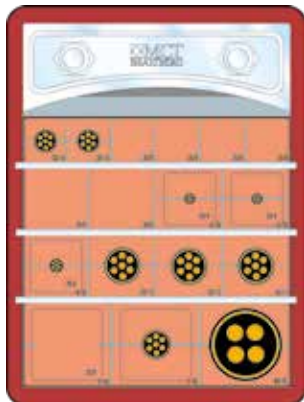

Regardless of cable diameter, you can retain the outer measurement of the block in any row.

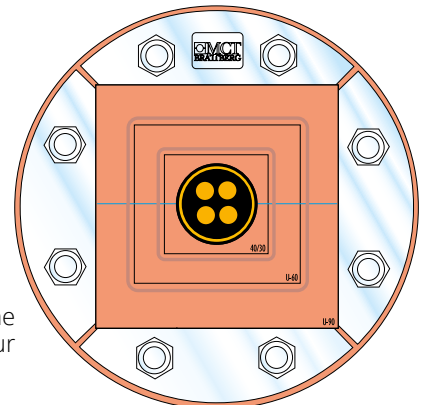

With U-Blocks, you can easily center the cable or pipe in your RGP installation.

# MSR cable glands

The MSR glands are designed to seal up to 8 cables between 4 and 32 mm (0.16" and 1.26") diameter.

The seal is easy to install. Just remove the center core and minimize the number of rings to enable cables to pass through. When all cables are inserted into the gland simply tighten the four Hex Screws equally. Once complete the seal will provide an effective barrier against fire, water, dust, vermin etc. No welding is required

- A 60 Lloyds certified
- Pressure tested upto 5 bar
- MED Modular B approved for use in cruise liners & passenger vessels
- Each gland accommodates a range of cable diameters
- No additional parts or on site machining required
- Gland manufactured from stainless steel
- Housing/body manufactured in electroplated mild steel



Description	Hole size reqd diameter		Minimum cable diam.		Maximum cable		No of cables	Weight incl. sleeve	
	mm	inches	mm	inches	mm	inches		Kg	(Oz)
MSR 20 Type 1	21	0.83	4	0.16	12	0.47	1	0.29	10.23
MSR 40 Type 1	41	1.61	11	0.43	24	0.94	1	0.47	16.58
MSR 40 Type 2	41	1.61	6	0.24	15	0.59	2	0.49	17.28
MSR 40 Type 3	41	1.61	6	0.24	12	0.47	4	0.47	16.58
MSR 50 Type 1	51	2.01	5	0.20	10	0.39	5	0.79	27.87
MSR 50 Type 2	51	2.01	4	0.16	16	0.63	3	0.78	27.51
MSR 50 Type 3	51	2.01	20	0.79	32	1.26	1	0.75	26.46
MSR 63 Type 1	64	2.52	4	0.16	16	0.63	4	1.0	35.27
MSR 63 Type 2	64	2.52	5	0.20	10	0.39	8	1.0	35.27



Dimensions in millimeter and inches. Weights in kilograms and Oz.  
Alternative cable configurations can be manufactured to suit specific customer requirements.

# SR cable and pipe seals

The SR glands are designed to seal cables or pipes between 4 and 100 mm (0.16 and 3.94") diameter. The seal can be supplied cut to allow pre terminated cable to be installed. It is supplied with a center core providing a seal prior to cable installation. When the cable is inserted into the gland, simply tighten the compression bolts equally until cable is secure. Once complete the seal will provide an effective barrier against fire, water, dust, vermin, etc.

- Lloyds certified
- Pressure tested to 5 bar
- Gland is manufactured from stainless steel 316L and rubber
- Sleeves are supplied in electroplated mild steel



Ref	No of cables	Cable diameter min		Cable diameter max		Sleeve O/D		Weight incl. sleeve	
		mm	(inches)	mm	(inches)	mm	(inches)	Kg	(Oz)
SR 25	1	4	0.16	12	0.47	33.4	1.31	0.21	7.41
SR 38-1	1	11	0.43	24	0.94	48.3	1.90	0.33	11.64
SR 38-2	2	6	0.24	15	0.59	48.3	1.90	0.35	12.35
SR 38-3	4	6	0.24	12	0.47	48.3	1.90	0.33	11.64
SR 49	1	20	0.79	32	1.26	60.3	2.37	0.56	19.75
SR 62	1	30	1.18	42	1.65	73	2.87	0.88	31.04
SR 77	1	42	1.65	52	2.05	88.9	3.50	1.30	45.86
SR 102	1	52	2.05	70	2.76	114.3	4.50	2.30	81.13
SR 125	1	70	2.76	85	3.47	141.3	5.56	3.41	120.28
SR 150	1	85	3.35	100	3.94	164	6.46	4.11	144.98

Dimensions in millimeter and inches. Weights in kilograms and Oz.  
Alternative cable configurations can be manufactured to suit specific customer requirements

# Deck and bulkhead penetration glands

A flexible penetration for single cables. No additional parts or on site machining required.  
Glands supplied in electro plated mild steel with brass nuts.  
Ability to fix to Metric threaded Conduit. Available with EMC/EMI protection.

This penetrations were in the beginning specifically developed for the British Royal Navy, but are now sold worldwide to various maritime applications, ships, oil platforms, gas carriers, cruise liners and more.

- Lloyds certified Pressure tested to 5 bar
- Certified to DEF STAN 02-510
- NATO stock coded
- Lloyds certified to A 60 Approval (metal housing)

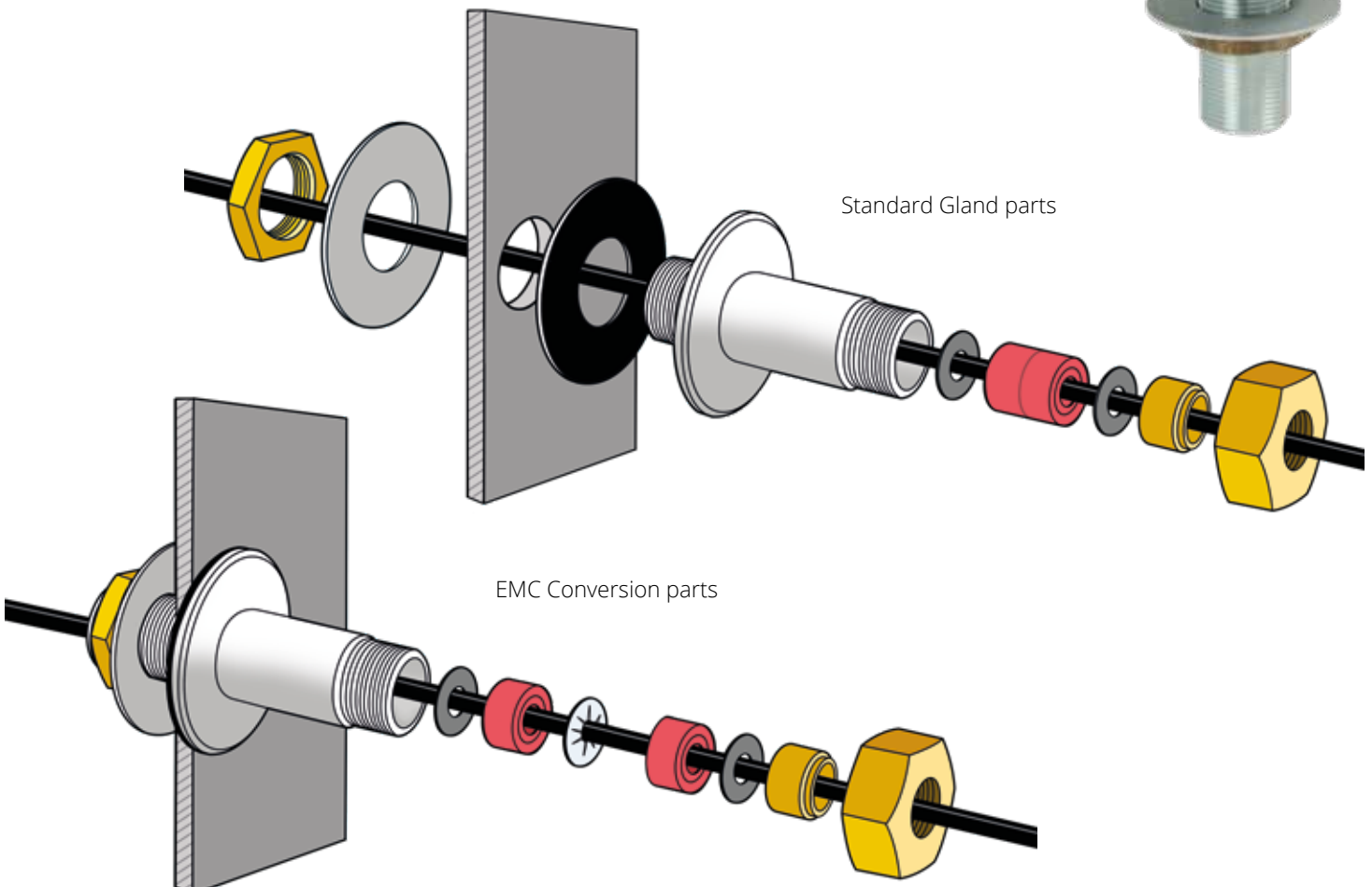

Ref	Cable range		Cable range		Metric thread	Flange diameter		Nut A/F		Weight	
	min mm	in	max mm	in		mm	in	mm	in	kg	lb
<b>150 mm (5.90") gland assembly with 30 mm ( 1.18") long thread</b>											
D&B 16-150-30	4	0.16	16	0.63	M33x2	70	2.76	46	1.81	1.45	3.20
D&B 25-150-30	13	0.51	25	0.98	M50x2	80	3.25	65	2.56	2.62	5.77
D&B 35-150-30	23	0.91	35	1.31	M60x2	100	3.94	80	3.15	3.51	7.74
D&B 50-150-30	32	1.26	50	1.97	M75x2	120	4.72	100	3.94	5.05	11.13
D&B 60-150-30	48	1.89	60	2.36	M90x2	150	5.98	120	4.72	7.42	16.36
<b>150 mm (5.90") gland assembly with 70 mm ( 2.76") long thread</b>											
D&B 16-150-70	4	0.16	16	0.63	M33x2	70	2.76	46	1.81	1.63	3.59
D&B 25-150-70	13	0.51	25	0.98	M50x2	80	3.25	65	2.56	3.03	6.68
D&B 35-150-70	23	0.91	35	1.31	M60x2	100	3.94	80	3.15	4.14	9.13
D&B 50-150-70	32	1.26	50	1.97	M75x2	120	4.72	100	3.94	5.71	12.59
D&B 60-150-70	48	1.89	60	2.36	M90x2	150	5.98	120	4.72	8.08	17.81
<b>75 mm (2.95") gland assembly with 30 mm ( 1.18") long thread</b>											
D&B 16-75-30	4	0.16	16	0.63	M33x2	70	2.76	46	1.81	1.02	2.25
D&B 25-75-30	13	0.51	25	0.98	M50x2	80	3.25	65	2.56	1.81	3.99
D&B 35-75-30	23	0.91	35	1.31	M60x2	100	3.94	80	3.15	2.48	5.47
D&B 50-75-30	32	1.26	50	1.97	M75x2	120	4.72	100	3.94	3.55	7.83
D&B 60-75-30	48	1.89	60	2.36	M90x2	150	5.98	120	4.72	6.20	13.67
<b>75 mm (2.95") gland assembly with 70 mm ( 1.18") long thread</b>											
D&B 16-75-70	4	0.16	16	0.63	M33x2	70	2.76	46	1.81	1.19	2.62
D&B 25-75-70	13	0.51	25	0.98	M50x2	80	3.25	65	2.56	2.11	4.65
D&B 35-75-70	23	0.91	35	1.31	M60x2	100	3.94	80	3.15	2.94	6.48
D&B 50-75-70	32	1.26	50	1.97	M75x2	120	4.72	100	3.94	4.20	9.26
D&B 60-75-70	48	1.89	60	2.36	M90x2	150	5.98	120	4.72	6.95	15.32

# X-series cable transit

The MCT Brattberg X-series is a truly unique cable transit system which features an instant SNAP-FIT cable seal designed to accommodate any cable diameter from 2,5mm (0.1") right up to 34,5mm (1.36"), with the flexibility for future expansion of systems within existing frames.

Incorporating a simple staybar securing mechanism, no special tools are required to assemble this ultra-lightweight unit. Because until installation, seals are not subject to any compression, they are sure to stay perfectly shaped and will not suffer from deformation. The unit is sealed prior to cabling, requires no painting and maintenance is kept to an absolute minimum.



## Frames

### Specification

- Polyester glass filled compression moulding
- UV stabilised material with low smoke
- Ultra low weight
- High strength

### Frames supplied with:

- Compression screws (M6 countersunk head)
- Compression system
- Gasket
- Optional extras include adaptor flange, Blanking pl Allen key. Details on request

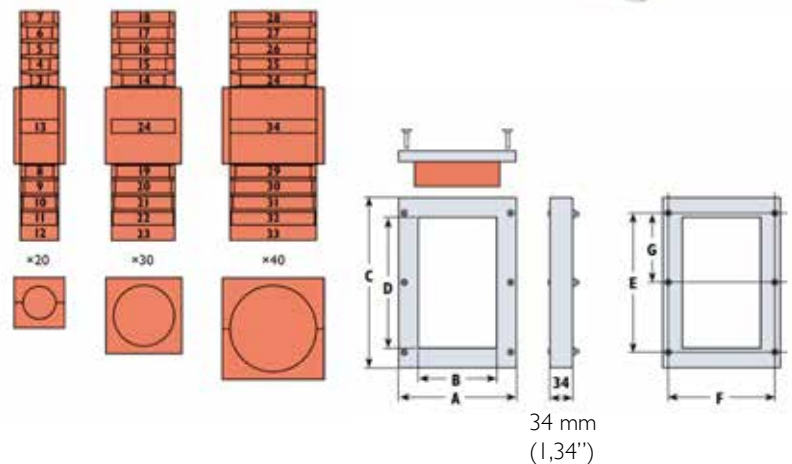

### Staybars

Stainless steel 3 mm (0.12") diameter available in 2 sizes.

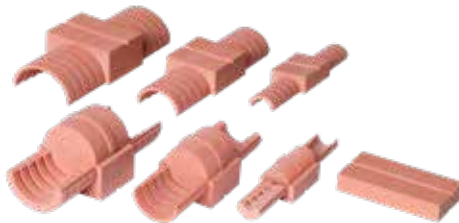

Type 1 120 mm

(4.72") long ref SB 120

Type 2 60 mm

(2.36") long ref SB 60

## Sizes

Type	A	B	C	D	A	B	C	D
	mm				Inches			
X1	178	120	260	200	7.01	4.72	10.24	7.87
X2	118	60	210	150	4.65	2.36	8.27	5.91

N.B multiple frames are available.

Details on request.

## Fixing Hole Dimensions

Type	E	F	G	E	F	G
	mm			Inches		
X1	215	160	107,5	8.46	6.3	4.23
X2	118	60	210	5.12	3.46	8.27

N.B sold as complete modules (2 halves & Plug)

Block sizes	E	F	G	E	F	G
	mm			Inches		
X20/3-13	20	10	2,5-13,5	0.79	0.39	0.1 - 0.53
X30/14-24	30	15	13,5-24,5	1.18	0.59	0.53-0.96
X40/24-34	40	20	23,5-34,5	1.57	0.79	0.93 - 1.36

N.B sold as complete modules (2 halves & Plug)

# ALF-Cabinet seal

ALF cabinet seal is a cable penetration for applications where dust- and water tightness are demanded. A lot of cables can be installed in a small area and the big opening even allows connectors and joints to pass through.

The cables are individual sealed off with 30 mm (1.18") insert blocks which comes in the same sizes as MCT Brattberg Standard Blocks, AddBlocks and HandiBlocks. ALF is compressed with two bolts and a standard allen key. The seal is easy to open up for changing or completion of cables.

## Advantages

- All cables through one opening (also with connector)
- Available as EMC
- Many cables in a limited area
- Specifications of cable sizes are no problem
- Easy changing/adding cables afterwards
- Dust- and waterproof (IP67)
- Assembly without special tools
- For cables with diameters from 3- 54 mm (0.12 – 2.13")
- Supplied complete with gasket, bolts and nuts
- Tested and approved



The frames are available in several different sizes

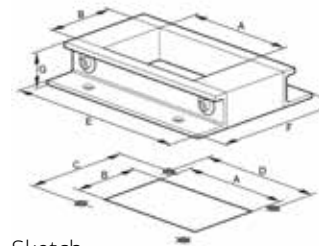

Sketch

## Performances

- Aluminum (standard) or stainless steel
- Standard dimensions or custom
- Supplied complete with gaskets, nuts and bolts
- Available certifications
- IP 67 according to IEC / EN 60529
- UL 50 test certificate
- UL94 test certificate (approved for Class V0)
- NEMA, Type 3R and 4X & 12

Completion of cables.

ALF is available in aluminium or stainless steel and is always supplied in kit form with gasket, bolts and nuts.

Classified according to:

UL 94 VO UL50 NEMA 3R & 4X & 12

Enclosure IP 66 / IP 67

Also custom sizes available!

## Table

Size Length (mm)	Width (mm)	Weight (kg)
ALF 60	40	0,50
ALF 90	40	0.54
ALF 90x2	40	1.0
ALF 120	40	0.59
ALF 120x2	40	1.1
ALF 150	40	0.62
ALF 150x2	40	1.14
ALF 90+90	40	0,95
ALF 90+90x2	40	1.52
ALF 120+120 (240)	40	1.04
ALF 120+120x2 (240x2)	40	1.67
ALF 150+150 (300)	40	1.15
ALF 150+150x2 (300x2)	40	2.00

Size Length (mm)	Width (mm)	Weight (kg)
ALF 60	60	0.60
ALF 90	60	0.634
ALF 90x2	60	1.093
ALF 120	60	0.686
ALF 120x2	60	1.175
ALF 150	60	0.717
ALF 150x2	60	1.24
ALF 90+90	60	1.04
ALF 90+90x2	60	1.615
ALF 120+120 (240)	60	1.135
ALF 120+120x2 (240x2)	60	1.763
ALF 150+150 (300)	60	1.1
ALF 150+150x2 (300x2)	60	2.096

# RFCS-Cabinet seal

The unique MCT Brattberg RFCS is available in three basic sizes of 10, 12 & 16 with an extension provision to size 20, 24 & 32 respectively. Is an innovative openable/ retrofit alternative to heavy duty plug in connectors and cable glands plates in the cabinets.

MCT Brattberg RFCS frame provides: Space saving frames compare to conventional plug in connectors & cable glands. Unique MCT Brattberg compression wedge PTG40 that can be inserted from both sides of the frame.

Easy installation and availability with ready made packed kits including the sealing module as per customer requirements. Classifications: IP65, IP67 and NEMA 250 type 4x (hose down)

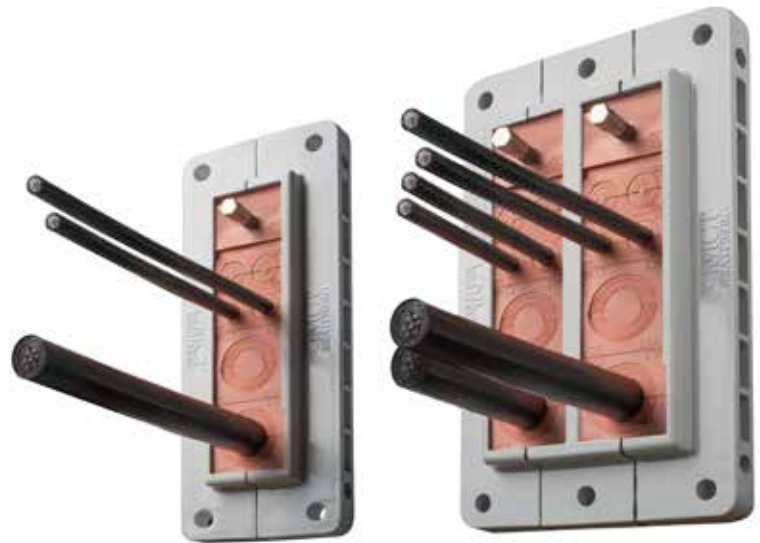

## MCT Brattberg RFCS Kit contains:

- Openable frame.
- RFCS modules marked with cable diameter.
- Compression wedge.
- Gasket for sealing frame to cabinet.
- Mounting Hardware.
- Installation Manual.
- Lubricant.

## Data

Modules: EPDM

## Aluminium:

Grade ADC-12

## Gasket between frame and cabinet:

EPDM

## Gasket between frame halves:

EPDM

## Plastic gasket washer:

LDPE

## Mounting hardware:

SS-304

EPDM is Halogen Free and Low smoke.

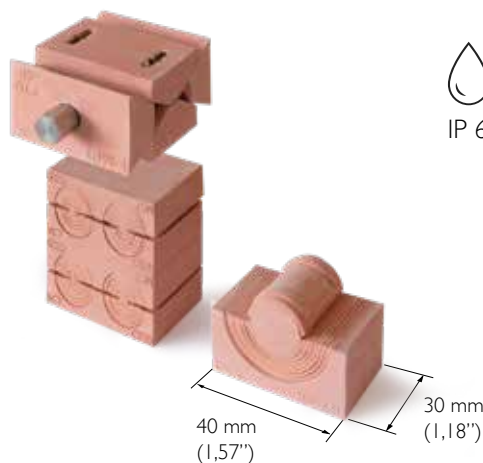



	Diameter range		Required cut out mm	Packing space mm	Diameter range		Required cut out inches	Packing space inches
	2,5-16,0 mm	14,5-33,0 mm			0,1-0,63 inches	0,57-1,3 inches		
<b>RFCS 10</b>	<b>Number of cables</b>				<b>Number of cables</b>			
RFCS 10/4	2	2	55x145	100x40	2	2	2.17x5.71	3.94x1.57
RFCS 10/7	6	1	55x145	100x40	6	1	2.17x5.71	3.94x1.57
RFCS 10/10	10	0	55x145	100x40	6	1	2.17x5.71	3.94x1.57
<b>RFCS 12</b>	<b>Number of cables</b>				<b>Number of cables</b>			
RFCS 12/3	0	3	55x165	120x40	0	3	2.17x6.5	4.72x1.57
RFCS 12/6	4	2	55x165	120x40	4	2	2.17x6.5	4.72x1.57
RFCS 12/9	8	1	55x165	120x40	8	1	2.17x6.5	4.72x1.57
RFCS 12/12	12	0	55x165	120x40	12	0	2.17x6.5	4.72x1.57
<b>RFCS 16</b>	<b>Number of cables</b>				<b>Number of cables</b>			
RFCS 16/4	0	4	55x205	160x40	0	4	2.17x8.07	6.3x1.57
RFCS 16/7	4	3	55x205	160x40	4	3	2.17x8.07	6.3x1.57
RFCS 16/10	8	2	55x205	160x40	8	2	2.17x8.07	6.3x1.57
RFCS 16/13	12	1	55x205	160x40	12	1	2.17x8.07	6.3x1.57
RFCS 16/16	16	0	55x205	160x40	16	0	2.17x8.07	6.3x1.57
<b>RFCS 20</b>	<b>Number of cables</b>				<b>Number of cables</b>			
RFCS 20/8	4	4	100x145	200x40	4	4	3.94x5.71	7.87x1.57
RFCS 20/14	12	2	100x145	200x40	12	2	3.94x5.71	7.87x1.57
RFCS 20/20	20	0	100x145	160x40	20	0	3.94x5.71	7.87x1.57
<b>RFCS 24</b>	<b>Number of cables</b>				<b>Number of cables</b>			
RFCS 24/6	0	4	55x205	160x40	0	4	2.17x8.07	6.3x1.57
RFCS 24/12	4	3	55x205	160x40	4	3	2.17x8.07	6.3x1.57
RFCS 24/18	8	2	55x205	160x40	8	2	2.17x8.07	6.3x1.57
RFCS 24/24	12	1	55x205	160x40	12	1	2.17x8.07	6.3x1.57
<b>RFCS 32</b>	<b>Number of cables</b>				<b>Number of cables</b>			
RFCS 32/8	0	8	100x205	320x40	0	8	3.94x8.07	12.6x1.57
RFCS 32/14	8	6	100x205	320x40	8	6	3.94x8.07	12.6x1.57
RFCS 32/20	16	4	100x205	320x40	16	4	3.94x8.07	12.6x1.57
RFCS 32/26	24	2	100x205	320x40	24	2	3.94x8.07	12.6x1.57
RFCS 32/32	32	0	100x205	320x40	32	0	3.94x8.07	12.6x1.57

RFCS

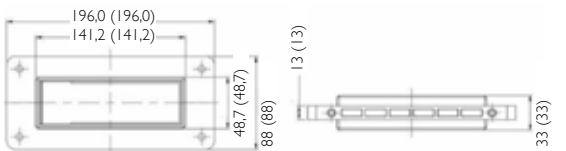

RFCS

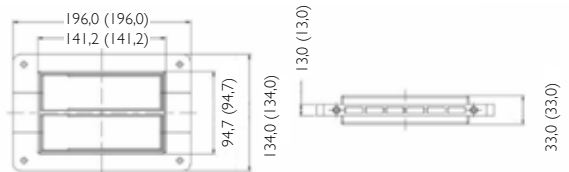

RFCS 12

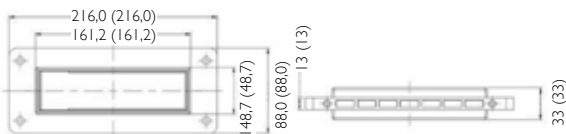

RFCS

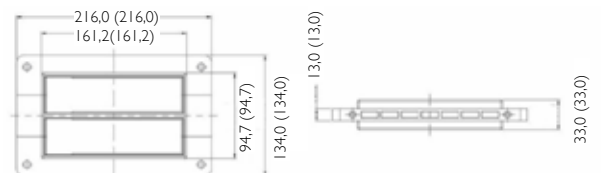

RFCS

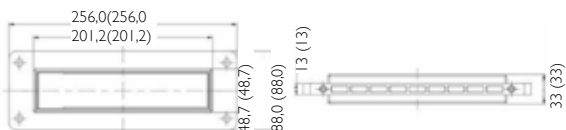

RFCS

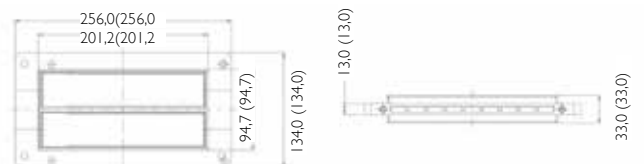



# Under Pressure



Custom designed pressure sealings  
up to 100 bar water pressure



Putting  
safety first

# Special products for special uses

MCT Brattberg manufactures a number of special products. High pressure secure cable and pipe penetration, penetrations for wave guides and blocks with built-in protection against electromagnetic pulse due to lightning or nuclear blast.

## **High pressure seals**

are an example of our special products. Several types of high pressure seals are available. Often these have been designed in collaboration with a customer. They are used, for example, in the supporting legs of oil rigs or in submarines. An example is the RGPH seal, which is type approved to 40 bar water pressure.

# PHP

## Pressure Hull Penetration

- **Custom designed**
- **Pressure tested up to 100 bar**
- **Tested and inspected acc. to specification**
- **EMP-version available**

The PHP longitudinal cable penetration is used as protection against incoming over pressure media/water through the pressure hull, vessels or barriers via the cables which have been damaged or cut. Application dimensions and cable types for the PHP are decided by the customer. Generally the PHP provides the same requirements as the cable.

PHP penetrations are currently used in both submarines and oil platforms.

Metal parts can be supplied in different materials according to customers requirement.

### Two types of PHP are available:

**LVT Longitudinal sealed** (The basic type of PHP)  
When a cable on the high pressure side (HP) is cut off, PHP stops incoming water and protects the low pressure side (LP) from over pressure and water.

The LVT protection is intact even when the whole moulding on the HP side has been cut off.



### LVTT Longitudinal and cross sealed

If one or more of the cables on the HP side are damaged or cut off, these cables will be blocked, while the un-damaged cables are still intact.

Both types (LVT and LVTT) can be supplied with built-in protection against EMP (electromagnetic pulse due to lightning and nuclear blast).

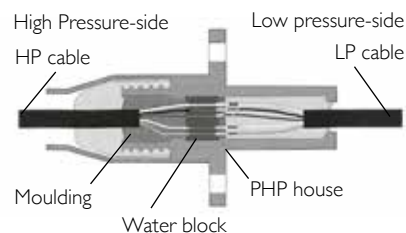

### Typical technical data (acc. to customer demands)

Hydrostatic pressure:	Test pressure: 9 MPa (90bar) or acc. to specification.
Shock:	Mechanical: 2000 g acc. to IEC 60068-2-27
	Hydrostatic: 213 bar/6 ms
Work temp. range:	Min. -40°C , Max. +70°C
EMP:	Peak 1 kA, raise and fall time 30 ns
Longitudinal seal:	Min. 10-6 cc/s air with 1 bar diff.

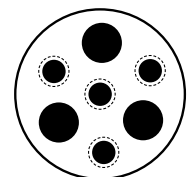

- Dashed circles: Damaged cables, with incoming water, will be stopped by the PHP.
- Solid circles: Insert cables with full electrical function.

### Following testing and inspections are available upon request

- Dimension and visual inspection
- Radiographic examination of moulding
- Leak detection test
- Hydrostatic pressure test
- High voltage test
- Insulation resistance test
- Conductor continuity and function test
- Result verification and inspection report/certificate
- Or other tests specified by the customer

# LSJ

## Longitudinal sealing joint

- **Custom designed**
- **Pressure tested up to 100 bar**
- **Tested and inspected acc. to specification**
- **EMP-version available**

The LSJ longitudinal cable joint is used as protection against incoming over pressure media/water through the pressure hull, vessels or barriers via the cables which have been damaged or cut. Application dimensions and cable types for the LSJ are decided by the customer. Generally the LSJ provides the same requirements as the cable.

LSJ penetration are currently used in both submarines and oil platforms. Metal parts can be supplied in different materials according to customers requirement.

Two types of LSJ are available:

### **LVT Longitudinal sealed (The basic type of LSJ).**

When a cable on the high pressure side (HP) is cut off,

#### **Typical technical data (acc. to customer demands)**

Hydrostatic pressure:	Test pressure: 9 MPa (90bar) or acc. to specification.
Shock:	Mechanical: 2000 g acc. to IEC 60068-2-27
Work temp. range:	Min. -40°C , Max. +70°C
EMP:	Peak 1 kA, raise and fall time 30 ns
Longitudinal seal:	Min. 10-6 cc/s air with 1 bar diff.

### **Following testing and inspections are available upon request**

- Dimension and visual inspection
- Radiographic examination of moulding
- Leak detection test
- Hydrostatic pressure test
- High voltage test
- Insulation resistance test
- Conductor continuity and function test
- Result verification and inspection
- Report/certificate
- Or other tests specified by the customer



LSJ stops incoming water and protects the low pressure side (LP) from over pressure and water.

### **LVTT Longitudinal and cross sealed**

If one or more of the cables on the HP side are damaged or cut off, these cables will be blocked, while the undamaged cables are still intact.

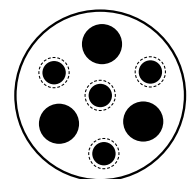
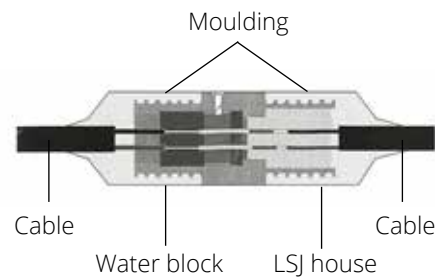
Both types (LVT and LVTT) can be supplied with built-in protection against EMP (electromagnetic pulse due to lightning and nuclear blast).



-  Damaged cables, with incoming water, will be stopped by the LSJ Insert
-  cables with full electrical function.

# Encapsulation of Sensors and Connectors

- **Custom designed**
- **Tested and inspected acc. to specification**

The encapsulation of sensors and connectors are used to ensure a watertight seal. Application dimensions and types of sensors and connectors are decided by the customer. The sensors and connectors are currently used in different types of submarines.

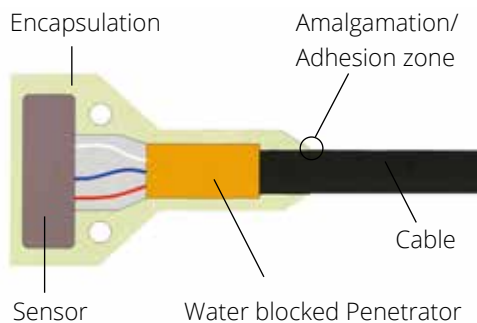
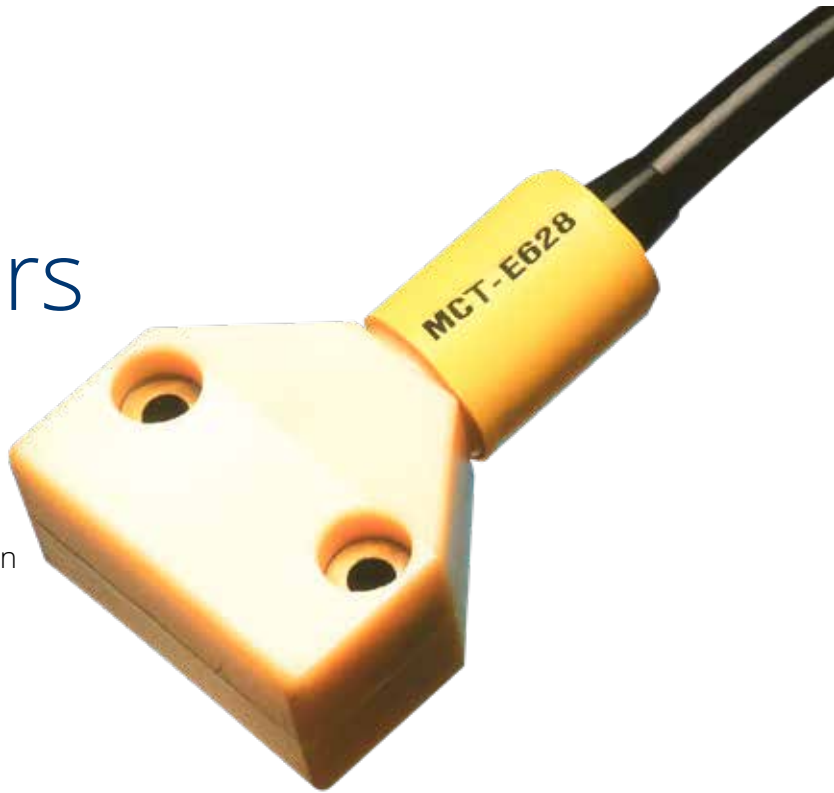

## Typical technical data (acc. to customer demands)

Hydrostatic pressure:	Test pressure: 5MPa (50 bar) or acc. to specification.
Shock:	Mechanical: 2000 g acc. to IEC 60068-2-27 Hydrostatic: 213 bar/6 ms
Temp. range:	Min. -40°C , Max. +70°C
EMP:	Peak 1 kA, raise and fall time 30 ns
Longitudinal seal:	Min. 10 <sup>-6</sup> cc/s air with 1 bar diff. pressure

## Following testing and inspections are available upon request

- Dimension and visual inspection
- Radiographic examination of moulding
- Leak detection test
- Hydrostatic pressure test
- vHigh voltage test
- Insulation resistance test
- Conductor continuity and function test
- Result verification and inspection
- Report/certificate
- Or other tests specified by the customer

# RGPM Pressure Sealing for cables and pipes



- **Custom designed**
- **Type approved to 15 bar water pressure**
- **DNV-GL and ABS approved**

## **Description**

The RGPM pressure seal is used when running cables and pipes through a section under or close to water, and to form a water-sealed unit with the section of almost unlimited designations of numbers and dimensions of cables and pipes. Approved for a continuous pressure up to 15 bar.

The design of a RGPM is made according to customers specification. The diameter could vary from 50 to 200 mm (1.97 to 7.87") and it could be designed for one single cable or pipe as well as for several cables/pipes. The outer diameter of the RGPM pressure seal is designed to match the inner diameter of the pipe or hole into which the unit is to be fitted.

The seals are normally made from Nitril rubber but other material can be used. Fittings are either stainless steel, hot galvanized or in other materials according to customers requirements.

The RGPM can also be installed and blind packed for installation of cables or pipes at a later stage.

In installation where the pressure could vary, a self-sealing version of RGPM can be used. The seal adjust itself according to the pressure.

## **Inspections and tests:**

Dimensional and visual inspected before delivery. Additional tests can be performed to clients specification.

## **Certificates and reports:**

- Factory Inspection and Test Report Certificate (optional)
- Material Test Certificate
- Type Approved by DNV-GL and ABS for pressure up to 15 bar

## **Instruction:**

A detailed instruction manual is supplied with the RGPM.

## **Capacity:**

Working pressure: 0-15 bar (water)



# RGPH High Pressure Sealing for cables and pipes



- **Custom designed**
- **Type approved to 40 bar water pressure**
- **DNV-GL and ABS approved**

## **Description**

The RGPH High Pressure Seal is for use in areas where extreme pressure tightness is required, i.e. the legs of offshore oil and gas platforms, subsea tie backs or between compartments in submarines. Our range of RGPH's are approved for up to 40 bar installations. They can also be on site tested after installation via test ports on the housing and a semipermeable membrane (optional) within the seal.

The RGPH has a high grade tubular steel housing and the cables are individually sealed by insert blocks. The pressure seal is achieved by steel fittings and bolts.

The RGPH can be designed to let any amount of cables through. As it is built on a modular system the number of cables through the penetration can easily be increased or decreased.

Each RGPH is designed specially to the customers need. The RGPH high pressure seal is available with flange for bolting or without flange for welding.

The RGPH is frequently used in offshore installations and in different types of submarines.

The RGPH system is available in six sizes designated based on the seal diameter RGPH-50, 70, 100, 125, 150 and 200 mm (1.97, 2.76, 3.94, 4.92, 5.91 and 7.87").

## **Inspections and tests:**

Dimensional and visual inspected before delivery. Additional tests can be performed to clients specification. It can be equipped with a tightness test function (semipermeable layer), which allows on site tightness testing after installation.

## **Certificates and reports:**

- Factory Inspection and Test Report Certificate (optional)
- Material Test Certificate
- Type Approved by DNV-GL and ABS for pressure up to 40 bar

## **Instruction:**

A detailed instruction manual is supplied with the RGPH.

## **Capacity:**

Working pressure: 0-40 bar (water)



# On Land



Putting  
safety first

# Safety above all



## DISCLAIMER

The author and publisher of this catalogue intend that this catalogue contain only general discussions and information; it is not intended to be comprehensive or to address all the possible contexts and situations involving the products and processes described herein. This catalogue is designed for generic study or research use only and is not a substitute for specific training or experience when utilizing the products and processes discussed herein. Nor is this catalogue intended to serve as a substitute for any proper training and/or certification needed for operation of the products and processes described herein. Accordingly, this catalogue is meant to be advisory and is not intended for specific application. Each application of the products and/or processes described herein may differ and the specifics involved must be addressed separately and individually depending on your situation.

MCT Brattberg (the "Company") assumes no liability for any use of or reliance upon any material contained or referenced in this catalogue; the use of this catalogue is at your own risk. THE COMPANY MAKES NO WARRANTIES, EXPRESS OR IMPLIED, INCLUDING WARRANTIES AS TO MERCHANTABILITY, AS TO THE FITNESS OF THE CATALOGUE OR ITS CONTENTS FOR ANY PARTICULAR USE OR PURPOSE, NON-INFRINGEMENT, OR AS TO THE ACCURACY, APPLICABILITY, OR COMPLETENESS OF THE CONTENTS OF THE CATALOGUE, AND SHALL NOT BE LIABLE

FOR ANY LOSS OR DAMAGE, DIRECTLY OR INDIRECTLY, ARISING FROM THE USE OF SUCH CATALOGUE OR FOR CONSEQUENTIAL DAMAGES. In no event shall Company be liable for: (a) punitive, incidental or consequential damages arising out of the use of the information from this catalogue, including, but not limited to, damage to persons or property, loss of use, loss of time, inconvenience, equipment rental, loss of earnings or profits, loss of business opportunities, or any other commercial loss, or (b) any losses, claims, damages, expenses, liabilities or costs (including legal fees) resulting directly or indirectly from use of the material in this CATALOGUE, WHICH IS PROVIDED "AS IS," AND WITHOUT WARRANTIES. The conditions in this paragraph apply to any acts, omissions and negligence of Company that would give rise to a course of legal action. The reader hereby agrees to indemnify and hold harmless Company its officers, directors, shareholders, employees, agents, subsidiaries, affiliates, parent companies and successors in interest against all claims and expenses (including attorney fees) arising from the use of any information in the catalogue. Further, Company is not responsible for any warranties of any nature made by any representative or agent that have not also been agreed to in writing by an officer of the Company.

364 - 388174v1 056390/000001

# Product program

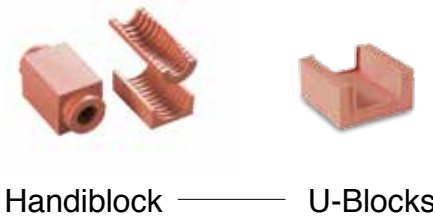
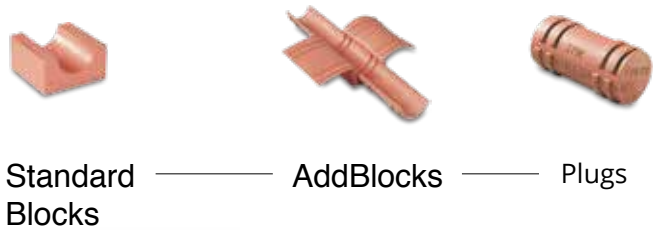
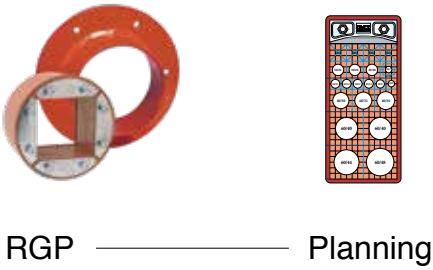
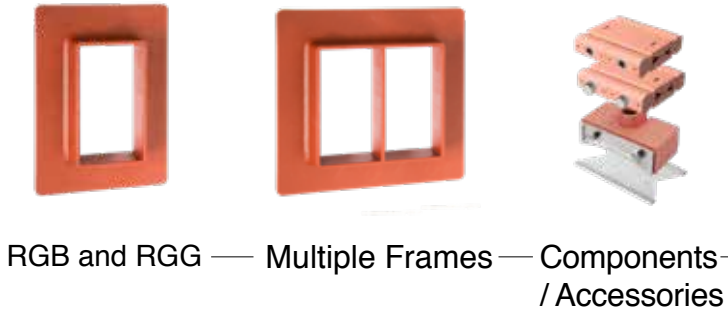

Putting safety first	Page 4
Certification and testing	Page 5
The original cable transit	Page 6
Special seals	Page 7
RGB and RGG	Pages 8-10
Multiple Frames	Page 11
Components / Accessories	Pages 12-13
RGP	Pages 14-15
Planning	Pages 16-19
Standard Blocks	Pages 20-21
AddBlocks / Plugs	Pages 22-23
HandiBlock / U-Block	Pages 24-25
Plugs	Pages 23
U-Blocks	Pages 25
X-series cable Transit	Page 26
Alf-Cabinet seal	Page 27
RFCS-Cabinet seal	Pages 28-29
Cable transit for rolling stock	Pages 30-33
Addresses see back page	

# The MCT Brattberg

# Putting Safety First

MCT Brattberg are constantly taking new steps to ensure the correct standard of assembled MCT transits.

We now offer:

## **INSPECTION**

- Ensuring MCT's meet relevant standards.
- Ensure that MCT's were installed to manufacturer's instructions.

## **TESTING**

Pressure testing transit to customer requirements.

## **TROUBLE SHOOTING**

- Assist and Consult on installation of difficult installations.

## **TRAINING**

Conduct onshore and offshore training classes to ensure that MCT's will be installed to code and to manufacturer's instruction.



# Tested, approved and certified

Since the early 1950s, when we first started specializing in fireproof and pressure-sealed transits, quality testing and classification has been essential.



## Tested by:

Aero Naval Lab. Inc. USA - Airo United Kingdom - AISH & Co United Kingdom Central Building Res. Institute United Kingdom - Central Building Res. Institute India Dantest Denmark - Dayton Brown USA - EMTECH Sweden - IBBM Germany International Research & Development United Kingdom - LCIE France Lab. National Dessais France - Loss Prevention Council United Kingdom National Defence Research Institute Sweden - RAPRA United Kingdom Saab Avionics Sweden - SINTEF Norway - Southwest Research USA Swedish National Testing Institute Sweden - Swiss Testing Service Switzerland TNO Netherlands - ULC Canada - Warrington United Kingdom



## Certified by:

Bundesamt für Zivilschutz Germany  
ETA Danmark A/S Denmark - Institut für Bautechnik Germany  
SINTEF Norway - SP Sweden - Swedish Rescue Services Agency Sweden

Please consult MCT Brattberg for latest updated certificates and approvals.

In 1986 our sealing method and quality system was adapted to meet the rigid requirements of the offshore and nuclear industry, and have been continuously updated to current requirements.

Today MCT Brattberg is assessed and certified by DNV, in accordance with the Quality and Environment Management system standard EN ISO 9001 and 14001, for the design, manufacture and supply of fire barrier and sealed transit systems associated with cable and pipe routes in building and marine environments.

As a direct result of this achievement, quality and environmental assessments are carried out by DNV twice annually.

MCT Brattberg also holds quality certificates and approvals from a wide variety of classification institutions and customers.

# The original cable transit

Based on the simple but clever idea of a frame with Insert Blocks and an end seal, the MCT Brattberg is the original transit system.

The MCT Brattberg system was patented in the early 1950s. When oil rigs and nuclear power stations demanded cable and pipe installations with proven safety records, the MCT Brattberg system became a worldwide solution, we've been improving it ever since. Comprehensive documentation shows that its resistance to fire, water, gas and pressure meets the latest safety requirements.

## The industry standard

Our own experience has shown that for a standard frame used for maritime applications, an internal width of 120.5 mm (4.74") a depth of 60 mm (2.36") and wall thickness of 10 mm (0.39") are optimal window sizes for maintaining structural strength and for fitting insert blocks. The welded corners are rounded for added strength. Both single and multiple transits frames are available.

The dimensions of the various frames have become the industry standard simply because these types of frames were the first to be introduced and have proved successful over time.

## Built in flexibility

The comprehensive range of frames, standard Blocks and other components of our transits provides remarkable application flexibility. In addition, our product range covers insulation collars and special solutions for EMC transits, SR cable and pipe seals, deck/bulkhead glands.

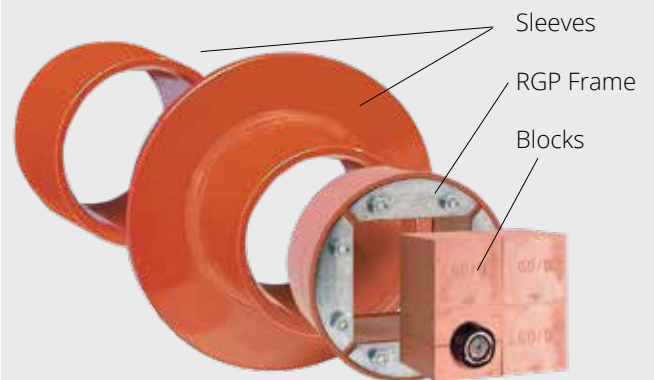
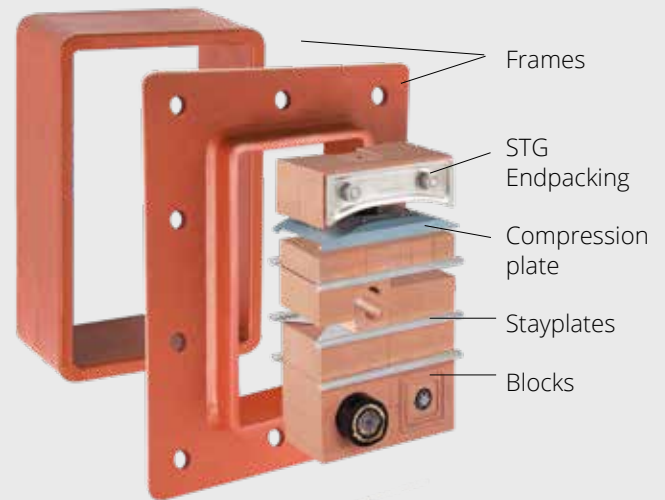
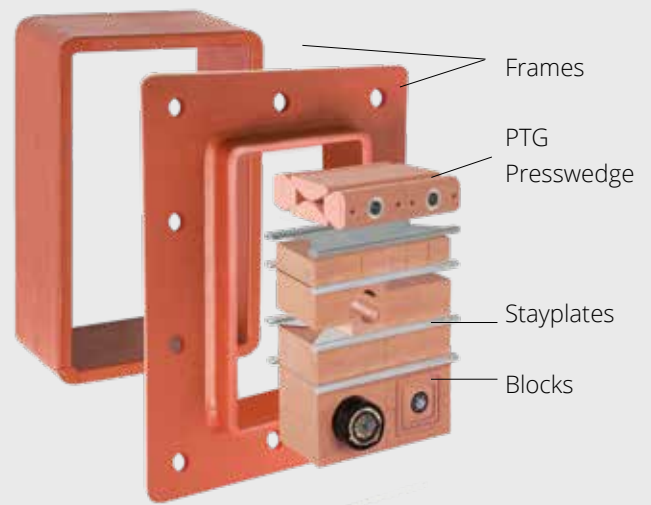



# Special products for specific uses

MCT Brattberg manufactures a number of special products. High pressure secure cable transits, transits for wave guides and blocks with built-in protection against electromagnetic pulse due to lightning or nuclear blast.

## High pressure seals

is an example of our special products. Several types of high pressure seals are available. Often these have been designed in collaboration with a customer. They are used, for example, in the supporting legs of oil rigs or in submarines. An example is the RGPH seal, which is certified up to 66.7 bar.

## The E-series

and components provide the same protection as the standard MCT Brattberg system but with added, built-in protection against electromagnetic pulses caused by lightning or nuclear blast.

They also give protection against interference, electronic sabotage and static electricity.

All dimensions are exactly the same as for the other MCT Brattberg components.

The E-series are approved for Grounding and Bonding.

## ATEX and IECEx certified transits

In explosion hazardous environments, it's important to have Ex equipment. MCT Brattberg has a specific program for this areas with products that are tested and certified according to the ATEX directive and the international IECEx. All dimensions are exactly the same as for the other MCT Brattberg components.

For special products please consult MCT Brattberg.



RGPH is certified up to 66,7 bar



EMC products for grounding and bonding.



Products to protect against explosions.

# RGB and RGG

## RGBO and RGGO with removable end

RGB is MCT Brattbergs standard frame for casting into concrete. RGB comes in four different sizes, in varying height and designates RGB-2, RGB-4, RGB-6 and RGB-8. The width dimension is always the same, 120 mm (4.72") as, well as the depth 60 mm (2.36"). The frame profiles width are 60 mm (2.36") and the thickness of the material is 6 mm (0.24").



RGB

RGBO

The RGG frame has a standard size flange and pre-drilled holes. The frame is screwed. When mounting through thick walls or floors, the RGG frame can be used together with a pre-drill counterstos to protect edges and keep any insulation in place. RGG has the same dimensions as RGB. The counterstos is available in three different depths to suit different wall thicknesses, see the Catalog's 2 last pages.

For installations where cable and / or pipes are already drawn, RGGO is used with openable end.

Information about combination frames can be found on page 11.

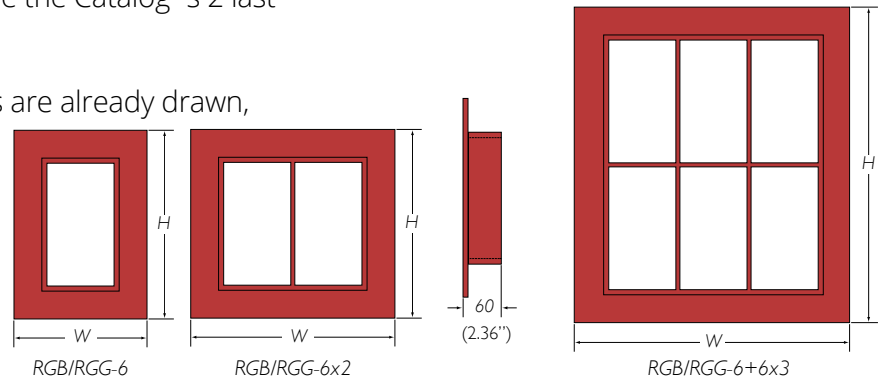

RGB/RGG-6

RGB/RGG-6x2

60  
(2.36")

RGB/RGG-6+6x3

Size in mm (Size in inches)																
H W (width) Combination frames																
FRAME SIZE	(height)	x 1	x 2	x 3	x 4	x 5	x 6		(height)	x 1	x 2	x 3	x 4	x 5	x 6	x n
RGB/RGG-2	221	240.5	371	501.5	632	762.5	893	W = 110+	8.7	9.47	10.67	19.74	24.88	30.2	35.16	W+4.33+
RGB/RGG-4	279.5	- " -	- " -	- " -	- " -	- " -	- " -	130.5 x n	11.0	- " -	- " -	- " -	- " -	- " -	- " -	5.14 x n
RGB/RGG-6	338	- " -	- " -	- " -	- " -	- " -	- " -		13.31	- " -	- " -	- " -	- " -	- " -	- " -	
RGB/RGG-8	396.5	- " -	- " -	- " -	- " -	- " -	- " -		15.61	- " -	- " -	- " -	- " -	- " -	- " -	
RGB/RGG-2+2	332	- " -	- " -	- " -	- " -	- " -	- " -		13.07	- " -	- " -	- " -	- " -	- " -	- " -	
RGB/RGG-2+4	390.5	- " -	- " -	- " -	- " -	- " -	- " -		15.37	- " -	- " -	- " -	- " -	- " -	- " -	
RGB/RGG-2+6	449	- " -	- " -	- " -	- " -	- " -	- " -		17.68	- " -	- " -	- " -	- " -	- " -	- " -	
RGB/RGG-2+8	507.5	- " -	- " -	- " -	- " -	- " -	- " -		19.98	- " -	- " -	- " -	- " -	- " -	- " -	
RGB/RGG-4+4	449	- " -	- " -	- " -	- " -	- " -	- " -		17.68	- " -	- " -	- " -	- " -	- " -	- " -	
RGB/RGG-4+6	507.5	- " -	- " -	- " -	- " -	- " -	- " -		19.98	- " -	- " -	- " -	- " -	- " -	- " -	
RGB/RGG-4+8	566	- " -	- " -	- " -	- " -	- " -	- " -		22.28	- " -	- " -	- " -	- " -	- " -	- " -	
RGB/RGG-6+6	566	- " -	- " -	- " -	- " -	- " -	- " -		22.28	- " -	- " -	- " -	- " -	- " -	- " -	
RGB/RGG-6+8	624.5	- " -	- " -	- " -	- " -	- " -	- " -		24.59	- " -	- " -	- " -	- " -	- " -	- " -	
RGB/RGG-4+8	683	- " -	- " -	- " -	- " -	- " -	- " -		26.89	- " -	- " -	- " -	- " -	- " -	- " -	

n = number of frames in width. Tolerances single frame: 3.5 mm (0.14").

Thickness of material 6 mm (0.24") except for internal horizontal and vertical walls in combination frames such as 10 mm (0.39").



RGG

RGGO

Standard frames in four different sizes: 2, 4, 6 and 8 which mark different heights. All have the same width. See below.

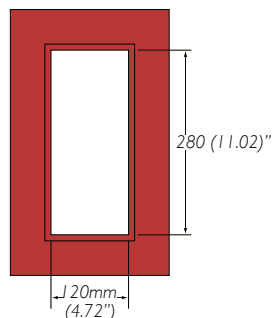
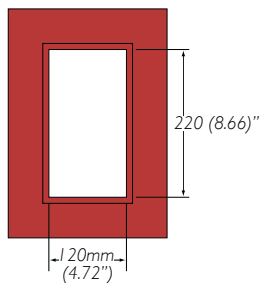
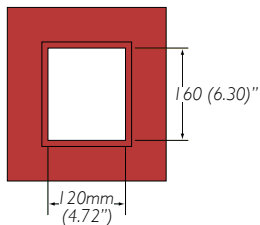
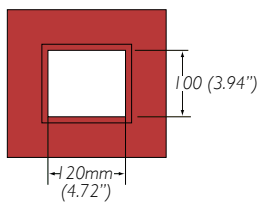

		Weight in kilograms						Weight in pounds						
		W (width) Combination frames												
MATERIAL	FRAME SIZE	x 1	x 2	x 3	x 4	x 5	x 6	x 1	x 2	x 3	x 4	x 5	x 6	
STEEL	RGB/RGG-2	3.1	5.0	6.9	8.8	10.7	12.6	6.8	11.0	15.2	19.4	23.5	27.7	
	RGB/RGG-4	3.8	5.9	8.1	10.2	12.4	14.6	8.3	13.0	17.8	22.4	27.5	32.1	
	RGB/RGG-6	4.4	6.8	9.2	11.5	13.8	16.3	9.7	14.9	20.2	25.3	30.4	35.9	
	RGB/RGG-8	5.0	7.7	10.4	13.1	15.8	18.5	11.0	16.9	22.9	28.8	34.8	40.7	
	SS EN 10025-S235JRG2	RGB/RGG-2+2	5.0	7.9	10.9	13.9	16.8	19.8	11.0	17.4	24.0	30.6	37.0	43.6
		RGB/RGG-2+4	5.6	9.0	12.4	15.7	19.1	22.4	12.3	19.8	27.3	34.6	42.1	49.3
		RGB/RGG-2+6	6.2	9.9	13.6	17.3	21.0	24.7	13.6	21.8	29.9	38.1	46.2	54.4
		RGB/RGG-2+8	6.9	11.0	15.1	19.2	23.3	27.4	15.2	24.2	33.2	42.3	51.3	60.4
	DIN RST 37-2	RGB/RGG-4+4	6.2	9.9	13.6	17.3	21.0	24.7	13.6	21.8	29.9	38.1	46.2	54.4
		RGB/RGG-4+6	6.9	11.0	15.1	19.2	23.3	27.4	15.2	24.2	33.2	42.3	51.3	60.4
		RGB/RGG-4+8	7.4	11.8	16.2	20.6	25.0	29.4	16.3	26.0	35.7	45.4	55.1	64.8
		RGB/RGG-6+6	7.4	11.8	16.2	20.6	25.0	29.4	16.3	26.0	35.7	45.4	55.1	64.8
BS 4360 gr. 40	RGB/RGG-6+8	8.1	13.0	17.9	22.7	27.6	32.4	17.8	28.6	39.4	50.0	60.8	71.4	
	RGB/RGG-8+8	8.9	14.2	19.5	24.9	30.2	35.5	19.6	31.3	42.9	54.8	66.5	78.2	
STAINLESS STEEL	RGB/RGG-2	3.2	5.1	7.1	9.0	11.0	12.9	7.0	11.2	15.6	19.8	24.2	28.4	
	RGB/RGG-4	3.9	6.1	8.3	10.5	12.7	14.9	8.5	13.4	18.2	23.1	27.9	32.8	
	RGB/RGG-6	4.5	6.9	9.4	11.8	14.2	16.7	9.9	15.2	20.7	26.0	31.3	36.8	
	RGB/RGG-8	5.2	7.9	10.7	13.5	16.2	19.0	11.4	17.4	23.5	29.7	35.7	41.8	
	DIN 1,4404	RGB/RGG-2+2	5.1	8.1	11.2	14.2	17.2	20.3	11.2	17.8	24.5	31.3	37.9	44.7
		RGB/RGG-2+4	5.8	9.2	12.7	16.1	19.6	23.0	12.7	20.2	27.9	35.4	43.2	50.7
		RGB/RGG-2+6	6.3	10.1	13.9	17.8	21.6	25.4	13.8	22.2	30.6	39.2	47.6	55.9
		RGB/RGG-2+8	7.1	11.3	15.5	19.7	23.9	28.1	15.6	24.9	34.1	42.4	52.6	61.9
	ASTM/316 L	RGB/RGG-4+4	6.3	10.1	13.9	17.8	21.6	25.4	13.8	22.2	30.6	39.2	47.6	55.9
		RGB/RGG-4+6	7.1	11.3	15.5	19.7	23.9	28.1	15.6	24.9	34.1	43.4	52.6	61.9
		RGB/RGG-4+8	7.6	12.1	16.6	21.1	25.6	30.1	16.7	26.6	36.5	46.5	56.4	66.3
		RGB/RGG-6+6	7.6	12.1	16.6	21.1	25.6	30.1	16.7	26.6	36.5	46.5	56.4	66.3
BS 970 gr. 316 S11	RGB/RGG-6+8	8.4	13.3	18.3	23.3	28.3	33.3	18.5	29.3	40.3	51.3	62.3	73.4	
	RGB/RGG-8+8	9.1	14.6	20.0	25.5	31.0	36.4	20.0	32.1	44.0	56.2	68.3	80.2	
ALUMINIUM	RGB/RGG-2	1.1	1.8	2.5	3.1	3.8	4.4	2.4	3.9	5.5	6.8	8.3	9.7	
	RGB/RGG-4	1.4	2.1	2.9	3.6	4.4	5.1	3.0	4.6	6.3	7.9	9.7	11.2	
	RGB/RGG-6	1.6	2.4	3.2	4.1	4.9	5.7	3.5	5.2	7.0	9.0	10.8	12.5	
	RGB/RGG-8	1.8	2.7	3.7	4.6	5.6	6.5	3.9	5.9	8.1	10.1	12.3	14.3	
	EN AW6082	RGB/RGG-2+2	1.8	2.8	3.9	4.9	5.9	7.0	3.9	6.1	8.5	10.8	13.0	15.4
		RGB/RGG-2+4	2.0	3.2	4.4	5.5	6.7	7.9	4.4	7.0	9.7	12.1	14.7	17.4
		RGB/RGG-2+6	2.2	3.5	4.8	6.1	7.4	8.7	4.8	7.7	10.5	13.4	16.3	19.1
		RGB/RGG-2+8	2.4	3.9	5.3	6.7	8.2	9.6	5.2	8.5	11.6	14.7	18.0	21.1
	DIN ALMG SI I A 6082	RGB/RGG-4+4	2.2	3.5	4.8	6.1	7.4	8.7	4.8	7.7	10.5	13.4	16.3	19.1
		RGB/RGG-4+6	2.4	3.9	5.3	6.7	8.2	9.6	5.2	8.5	11.6	14.7	18.0	21.1
		RGB/RGG-4+8	2.6	4.2	5.7	7.2	8.8	10.3	5.7	9.2	12.5	15.8	19.4	22.7
		RGB/RGG-6+6	2.6	4.2	5.7	7.2	8.8	10.3	5.7	9.2	12.5	15.8	19.4	22.7
BS H30/6082	RGB/RGG-6+8	2.9	4.6	6.3	8.0	9.7	11.4	6.3	10.1	13.8	17.6	21.3	25.1	
	RGB/RGG-8+8	3.2	5.0	6.9	8.7		12.5	7.0	11.0	15.2	19.1	23.3	27.5	
TFNS 17305														

# RGB and RGBO, RGG and RGGO

## PIPE TRANSITS

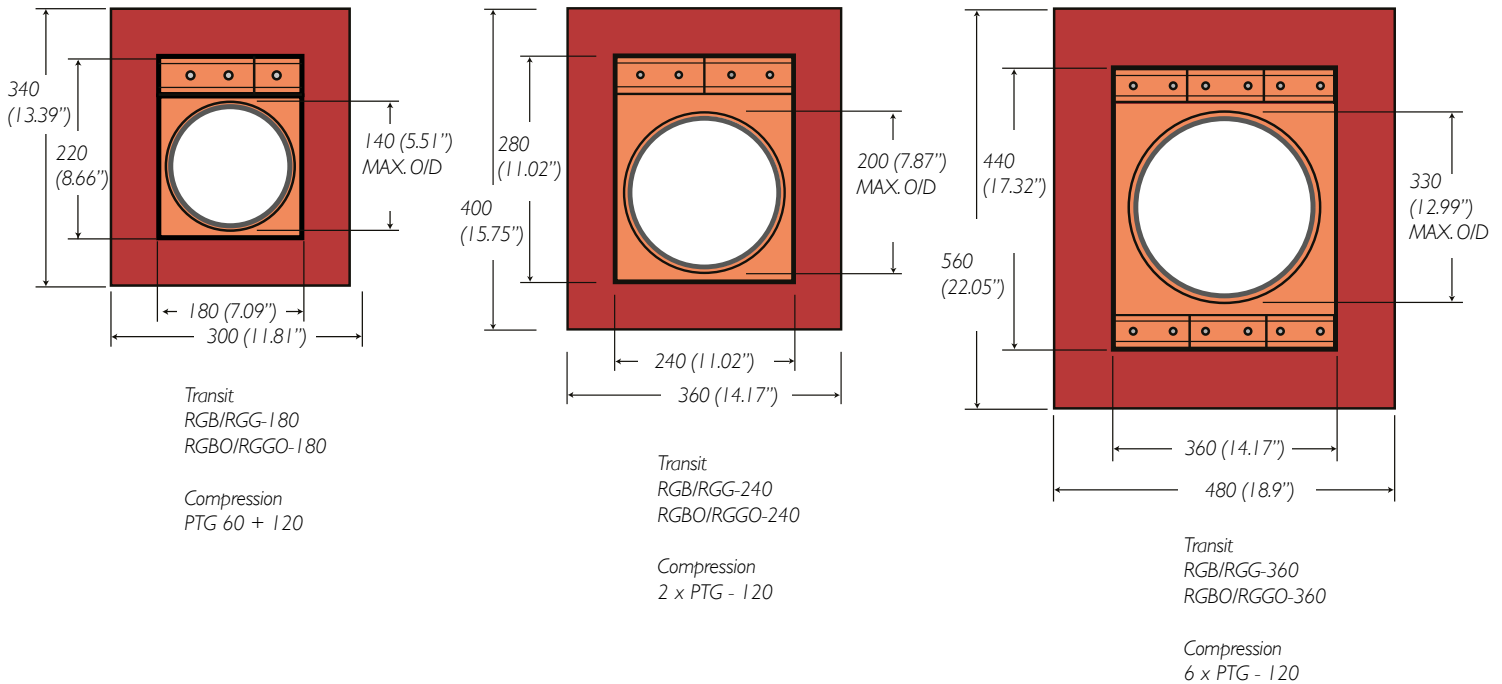

# RGB and RGG-1, 3, 5 & 7

## EXTRA SMALL WIDTH

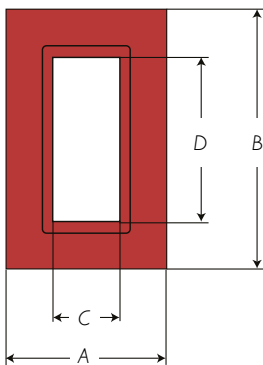

Frames size	Dimensions mm				Dimensions inches			
	A	B	C	D	A	B	C	D
RGB/RGG-1	180	221	60	100	7.09	8.7	2.36	3.94
RGB/RGG-3	180	279,5	60	160	7.09	11.0	2.36	6.30
RGB/RGG-5	180	338	60	220	7.09	13.3	2.36	8.66
RGB/RGG-7	180	396,5	60	280	7.09	15.6	2.36	11.02

# Multiple Frames

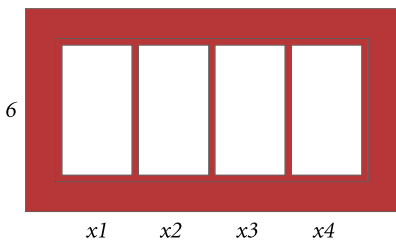

Designation: (frame type) 6x4

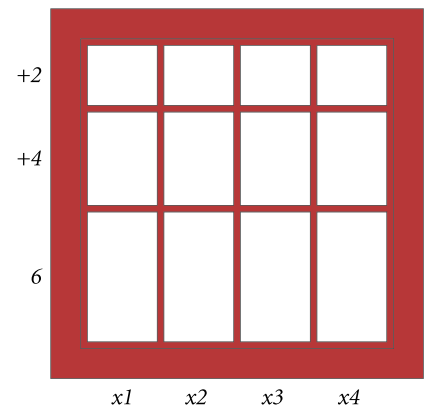
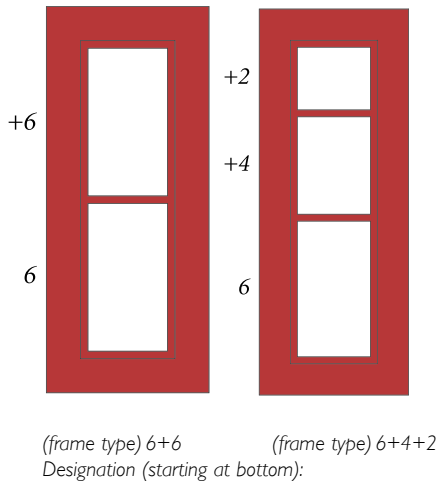

(frame type) 6+4+2x4

Designation (starting at bottom):

NOTE: All multiple frame designations must be preceded by the frame type

## HORIZONTAL MULTIPLE FRAMES

Horizontal multiple frames are described by listing the frame type and size x the desired number of horizontal openings.

## VERTICAL MULTIPLE FRAMES

Vertical multiple frames are described by listing the bottom frame type and size + the next frame type and size.

## VERTICAL AND HORIZONTAL MULTIPLE FRAMES

List the entire vertical frames x the desired number of horizontal repetitions.

# Components

## PTG-PRESSWEDGE

Can be used as an alternative to compression plate and STG. Can also be placed anywhere in the frame. Made of Lycron, with stainless steel fittings.

Must always be installed in combination with a stayplate.

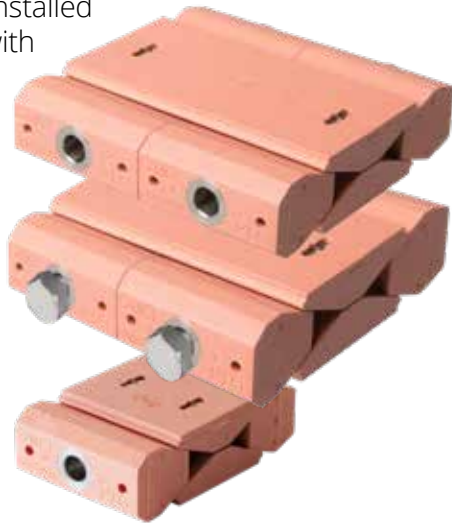

PTG Allen

PTG Hex

PTG Allen 60

## STG-ENDPACKING

Installed between compression plate and the top of the frame, completing the seal. Made of Lycron with galvanized or stainless steel fittings.



## LUBRICANT

30 g / 25 ml (0.07 pound / 0.85 oz)

For easier insallation and must be used with pressure-tight installation,



## STAYPLATE

To be placed between each row of blocks. Stayplates simplifies installation, increases stability and anchors blocks within the frame. Plates come in galvanized or stainless steel and aluminium.



Stayplate

Stayplate 60

## COMPRESSION PLATE

Usually assembled above top row of blocks. The plate bolt is tightened to compress blocks around cables, while providing room for STG endpacking. Comes in GRP, glassfibre reinforced polyester.



Component	Weight in kilograms	Weight in pounds
Compression Plate	0.24	0.53
STG	0.6	1.32
PTG 120 Hex and Allen	0.83	1.81
PTG 60 Hex and Allen	0.41	0.9
Stayplate	0.13	0.29
Stayplate 60	0.02	0.04

# Accessories

## SPACER TOOL

Simplifies insertion of last row of blocks.  
20, 30, 40 mm (0.79", 1.18", 1.57")

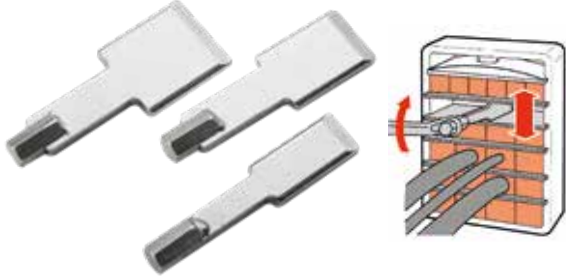

## BLOCK SELECTOR

For cable/pipe measurement.

STD insert



AddBlock



HandiBlock



## RING SPANNER

For end packer & RGP installation.



## CABLE SEPARATOR

Support cables during installation.



## PACKING TOOL

Compresses insert block to hold cable/pipes during partial installations.



## END PACKER PULLER

For re-entry into system.



## QUICK RELEASE SPANNER

For Compression Plate Installation.



## BLANKING PLATE

Seals frame prior to block installation.

Ingress protection IP65/66



# RGP-round holes

**RGP** is a Lycron transit frame for assembly in drilled holes, pipes or in MCT Brattberg sleeves (See Installation Guide, page 5 for dimensions of pipes and drilled holes). It is available in eight sizes (see table) and is packed with insert blocks. The metal parts are galvanized or stainless steel.

**RGPO** is a Lycron frame with open sides intended for installation in holes where cables have already been installed. This is also available in seven sizes.



RGP is a circular seal for holes or pipes.



RGPO is an openable RGP frame.

Weight in kilograms		Weight in pounds	
RGP 50	0,25	RGP 2"	0.6
RGP 70	0,4	RGP 3"	0.9
RGP 100	0,7	RGP 4"	1.5
RGP 125	1,0	RGP 5"	2.2
RGP 150	1,8	RGP 6"	4.0
RGP 200	3,0	RGP 8"	6.6
RGP 300	7,5	RGP 11.8"	16.5

FRAME SIZE	Dimensions in mm (inches)	
	PACKING AREA	DEPTH AND DIAMETER
RGP 50 (2")		
RGP 70 (3")		
RGP 100 (4")		
RGP 125 (5")		
RGP 150 (6")		
RGP 200 (8")		
RGP 300 (11.8")		



# Sleeves for RGP and RGPO Frame

MCT Brattberg standard sleeves are available in seven sizes, for welding or bolting to the structure.

The standard materials are mild steel, stainless steel and aluminium. SFRB is



SFRBO

SFR

SFRB

S

TYPE S Without flange

TYPE SFR with round flange

TYPE SFRB with round flange and pre drilled holes

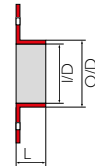
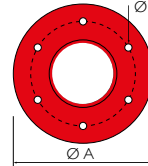
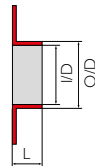
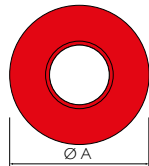
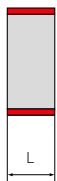
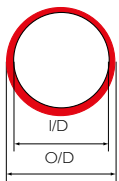

Type S without flange - Below dimensions does not apply to Aluminium, only stainless and mild steel.							
Type/Dimension	O/D mm	L mm	Weight kg	Type/Dimension	O/D inch	L inch	Weight lbs
S 50	63	82	0,7	2"	2.5	3.2	1.4
S 70	83	82	0,8	S-3	3.52	3.2	1.8
S 100	114	82	1,3	S-4	4.55	3.2	1.8
S 125	139	82	1,6	S-5	5.55	3.2	1.8
S 150	164	82	1,9	S-6	6.55	3.2	1.8
S 200	214	82	2,6	S-8	8.55	3.2	1.8
S 300	316	82	4,5	S-11.8	12.44	3.2	9.9

Dimensions for pipes and drilled holes see page 31

Dimensions for pipes and drilled holes see page 31

Sleeves can also be supplied to US Standard Diameters.

Type SFR and SFRB with round flange - Type S without flange - Below dimensions does not apply to Aluminium, only stainless and mild steel.													
Type/Dimension	O/D mm	L mm	A mm	E mm	Weight kg	Qty of holes	Type/Dimension	O/D inch	L inch	A inch	E inch	Weight lbs	Qty of holes
SFR/SFRB 50	63	86	145	9	1,4	4	SFR/SFRB 2"	2.48	3.4	6	0.35	2.8	4
SFR/SFRB 70	83	86	185	9	2,1	4	SFR/SFRB 3"	3.27	3.4	7.5	0.35	4.6	4
SFR/SFRB 100	114	86	215	9	2,9	4	SFR/SFRB 4"	4.49	3.4	8.5	0.35	6.4	4
SFR/SFRB 125	140	86	240	9	3,7	4	SFR/SFRB 5"	5.51	3.4	9.5	0.35	8.2	4
SFR/SFRB 150	164	86	264	11	4,2	6	SFR/SFRB 6"	6.46	3.4	10.5	0.43	9.3	6
SFR/SFRB 200	214	86	315	11	5,1	6	SFR/SFRB 8"	8.43	3.4	12.5	0.43	11.2	6
SFR/SFRB 300	316	86	398	11	8,5	10	SFR/SFRB 11.8"	12.44	3.4	15.7	0.43	18.7	10

Dimensions for pipes and drilled holes see page 31

Dimensions for pipes and drilled holes see page 31

# Planning the Packing Space

The space in a frame, which can be used exclusively for holding Insert Blocks, is called the packing space. In the RGS-type frames the compression system always occupies 40 mm (1.57") of each frame. In the RGP frames no compression system or stay-plates are necessary. Therefore the packing space consists of the entire interior area of the frame. Tables to help you determine which Insert Block to use are on pages 27 (the standard Blocks) 28 (AddBlocks)

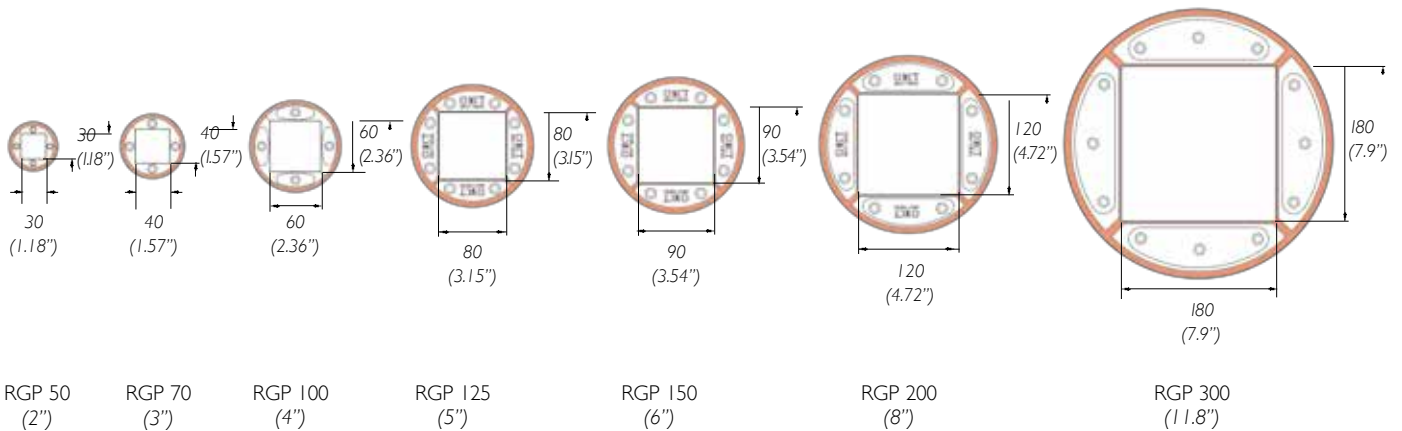
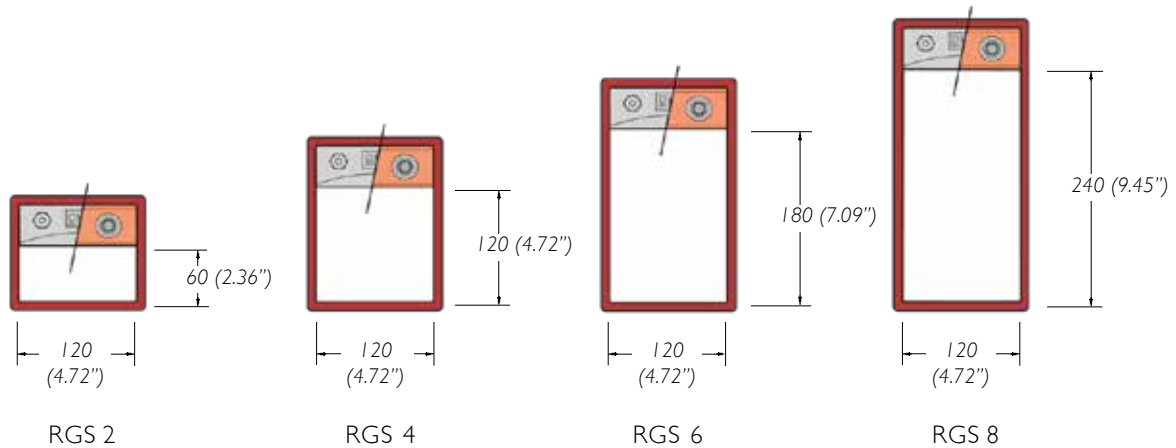

RGB maximum number of cables and pipes							
Frame sizes	Block sizes						
	15	20	30	40	60	90	120
RGB/RGG-2	32	18	8	3	2	-	-
RGB/RGG-4	64	36	16	9	4	1	1
RGB/RGG-6	96	54	24	12	6	2	1
RGB/RGG-8	128	72	32	18	8	2	2

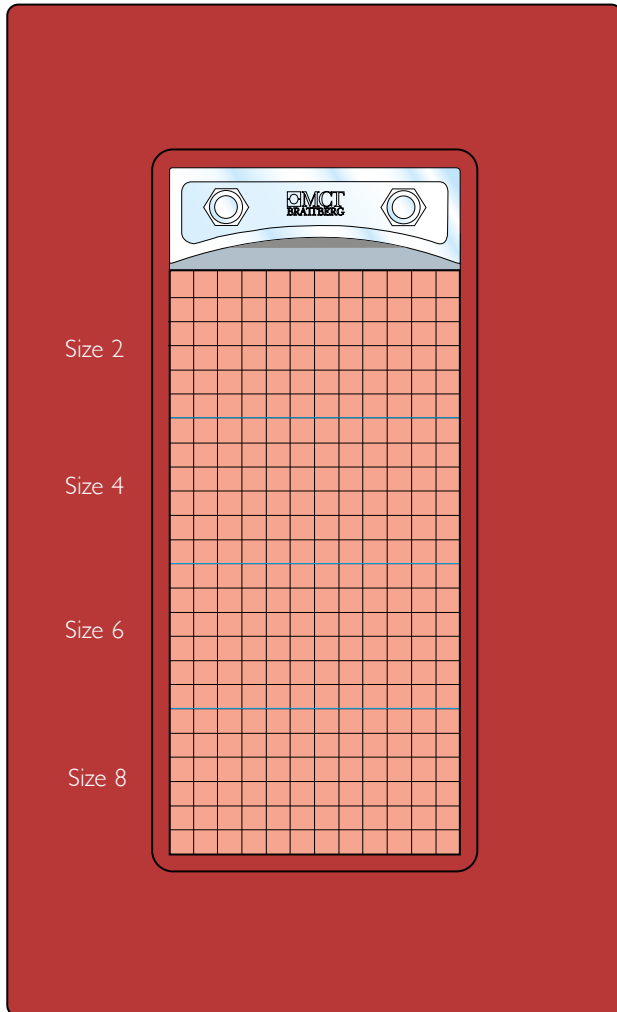

RGP maximum number of cables and pipes							
Frame sizes	Block sizes						
	15	20	30	40	60	90	120
RGP 50 RGP (2")	4	1	1	-	-	-	-
RGP 70 RGP (3")	4	4	1	1	-	-	-
RGP 100 RGP (4")	16	9	4	1	1	-	-
RGP 125 RGP (5")	25	16	4	1	1	-	-
RGP 150 RGP (6")	36	16	9	4	1	1	-
RGP 200 RGP (8")	64	36	16	9	4	1	1
RGP 300 RGP (11.8")	0	0	0	0	0	0	0

A couple of examples of pack plans (RG Plan) are shown here. RGB to the left and RGP below. The largest cables are placed at the bottom.

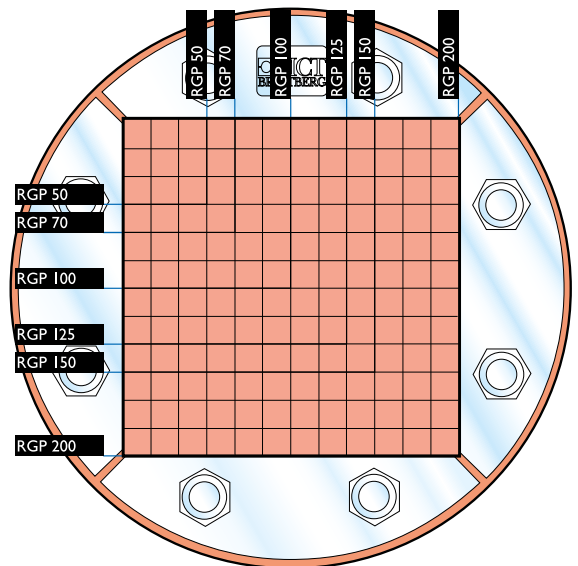

Combination frame width compared with width of cable tray						
Cable type	Frame size	Cable tray width in mm /inches				
		150 /5.91	200 /7.87	300 /11.81	400 /15.75	600 /23.63
Signal		6	6x2	6x3	6x4	6x5
Power		4	4x2	4x3	4x4	4x5
Combination		6	6x2	6x3	6x4	6x5

# Packing Plan

## RGB, RGG and RGP

The correct frame size can be determined by using this plan. The notes to the right side of the plan represent the available packing space for Frame sizes 2, 4, 6 and 8.

It is not necessary to show stay plates, compression plates or endpackings since sufficient space for these is already reserved in the tables.

The notes to the left side of the plan represent the available packing space for the different RGP frames.

Dimensions of Standard insert blocks, Add-blocks, Plugs and U-blocks, see pages 20-24.



RGP 50

RGP 70

RGP 100

RGP 125

RGP 150

RGP 200

10x10 mm

SIZE 2

SIZE 4

SIZE 6

SIZE 8

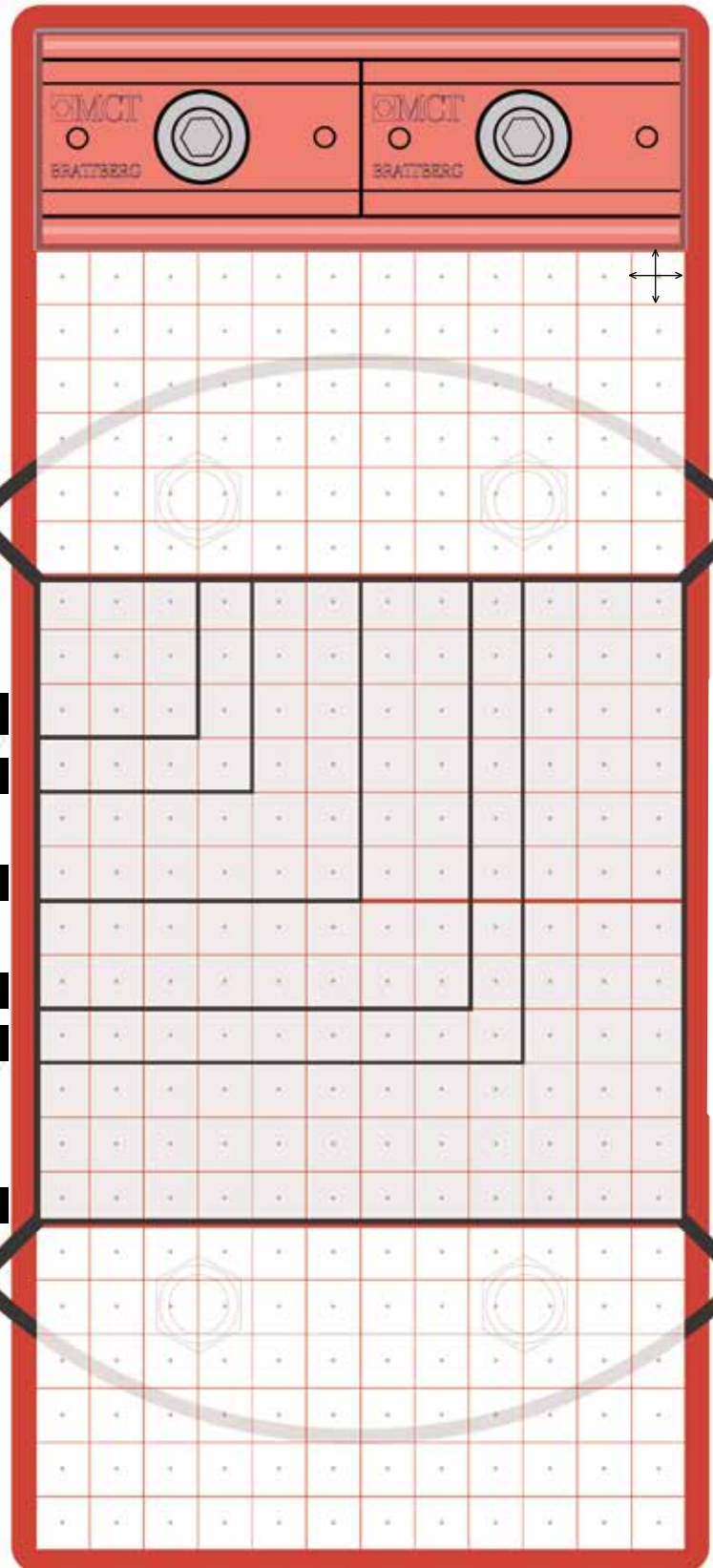

# RGPlan

## WEB-BASED DESIGN Software

Configure cable/pipe penetrations quickly and easily with our Web-based design software. It's faster and simpler than time-consuming manual methods. It's perfect solution for busy engineers/designers.

It's free and completely web based. Log in to access your projects anywhere. You can share projects with team members to allow them to edit and configure the transits. Built with smart functions, to help reduce your transit planning time. Simply input the transit requirements and RGPlan automatically configures the seal, along with all necessary components, Insert Blocks, stayplates and compression systems – at the touch of a button. The program now offers many unique editing features, multiple transit calculation and a simple format to deliver well designed MCT Brattberg transits.

Web-based design software gives a lot of opportunities, including following:

- Create a favorite list of your most used cables for easy access.
- Import new cables from Excel buy using a cable list template.
- Categorize and highlight placed cables for easy overview, for example to separate high voltage cables and sensitive data cables.
- Add team members to a project to allow them to edit and configure the transits within the project.
- Every progress you make is autosaved in realtime.
- Download project reports, Bom:s and drawings at any time.

Web-based design software  
The service is free of charge and no download is required. [rgplan.mctbrattberg.com](http://rgplan.mctbrattberg.com)

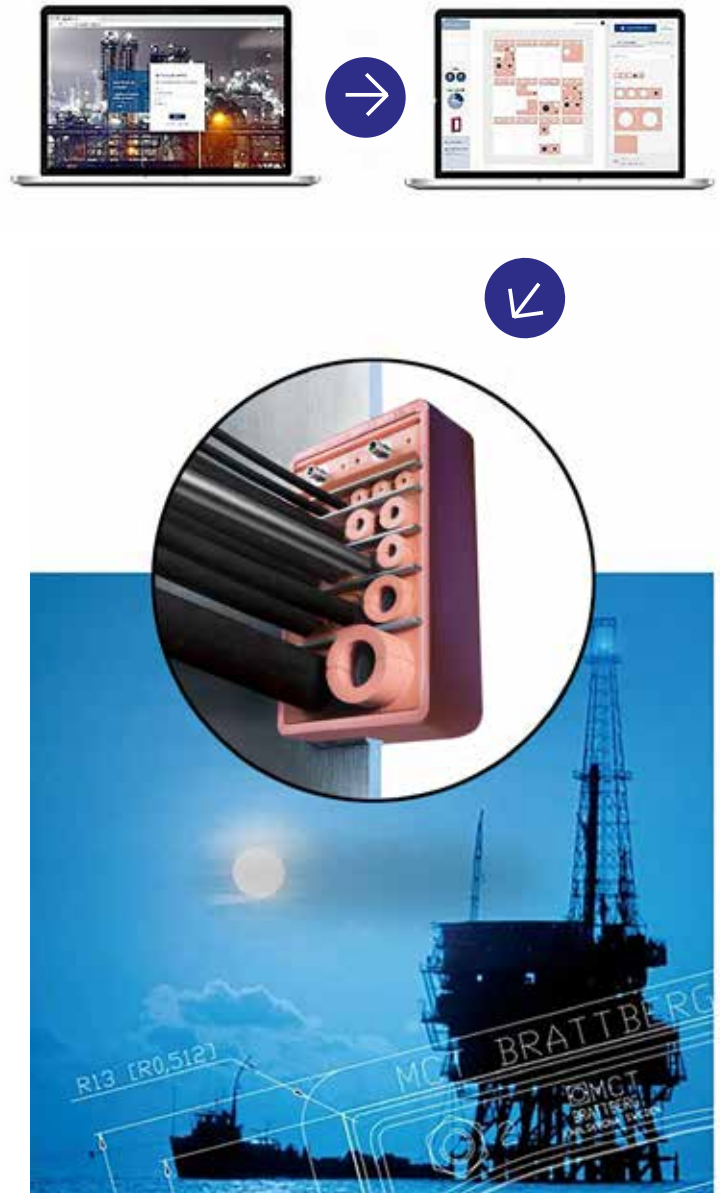

# Standard Blocks

Our range of blocks accommodates cables between 3,5 - 101,5 mm (0.14- 4.0") in diameter. It is important that the insert block is the right size, with respect to the cable, to ensure a proper seal.

Measure the cable diameters carefully and choose insert blocks accordingly. With the sizing chart on next page you can choose the correct size of insert blocks.

Blocks are referred to by their width (A) and hole diameter (B). Thus a block with a width of 15 mm (0.59") and a hole diameter of 4 mm (0.16") is referred to as 15/4. This designation is moulded into the block. Certain markets denote Insert Blocks in pairs. Please consult MCT Brattberg for this information.

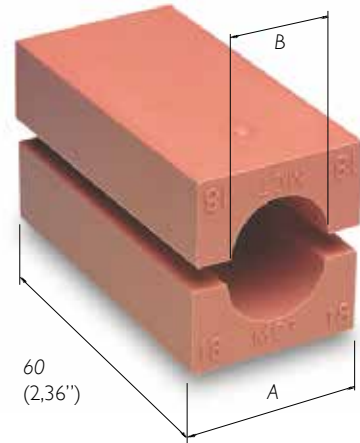

# SpareBlocks

Spare room in each frame is filled out with solid insert blocks. Called spares, they bear the designation A/0.

Blocks are referred to by their width (A), followed by the designation /0 (indicating solid). Thus a block with a width and height of 15 mm (0.59") is referred to as 15/0.

The length of insert blocks is always 60 mm (2.36")

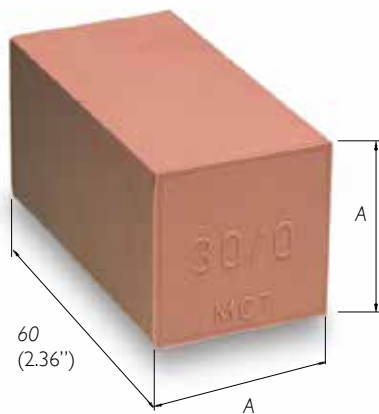

Block size in mm Width (A) = Height (A)	Size in inches	BLOCK DESIGNATION
5 x 5 Only in strips of 24 pcs	0.20" x 0.20" Only in strips of 24 pcs	24x5/0
10 x 10 Only in strips of 12 pcs	0.39" x 0.39" Only in strips of 12 pcs	12x10/0
15 x 15	0.59" x 0.59"	15/0
20 x 20	0.79" x 0.79"	20/0
30 x 30	1.18" x 1.18"	30/0
40 x 40	1.58" x 1.58"	40/0
60 x 60	2.36" x 2.36"	60/0
90 x 30	3.54" x 1.18"	90x30/0

CABLE DIAM.	A (mm)				B	CABLE DIAM.	A (mm)			B	CABLE DIAM.	A (mm)		B
	15	20	30	40			40	60	90			90	120	
3.5-4.5	15/4	20/4			4	25.5-27.5	40/26			26	55.5-57.5	90/56		56
4.5-5.5	15/5	20/5			5	27.5-29.5	40/28			28	57.5-59.5	90/58		58
5.5-6.5	15/6	20/6			6	29.5-31.5	40/30			30	59.5-61.5	90/60		60
6.5-7.5	15/7	20/7			7	31.5-33.5	40/32	60/32		32	61.5-63.5	90/62		62
7.5-8.5	15/8	20/8			8	33.5-35.5	40/34	60/34		34	63.5-65.5	90/64		64
8.5-9.5	15/9	20/9			9	35.5-37.5		60/36		36	65.5-67.5	90/66		66
9.5-10.5		20/10			10	37.5-39.5		60/38		38	67.5-69.5	90/68		68
10.5-11.5		20/11			11	39.5-41.5		60/40		40	69.5-71.5	90/70		70
11.5-12.5		30/12			12	41.5-43.5		60/42		42	71.5-73.5		120/72	72
12.5-13.5		20/13	30/13		13	43.5-45.5		60/44		44	73.5-75.5		120/74	74
13.5-14.5		20/14	30/14		14	45.5-47.5		60/46		46	75.5-77.5		120/76	76
14.5-15.5			30/15		15	47.5-49.5		60/48		48	77.5-79.5		120/78	78
15.5-16.5			30/16		16	49.5-51.5		60/50	90/50	50	79.5-81.5		120/80	80
16.5-17.5			30/17		17	51.5-53.5		60/52	90/52	52	81.5-83.5		120/82	82
17.5-18.5			30/18		18	53.5-55.5		60/54	90/54	54	83.5-85.5		120/84	84
18.5-19.5			30/19		19						85.5-87.5		120/86	86
19.5-20.5			30/20		20						87.5-89.5		120/88	88
20.5-21.5			30/21		21						89.5-91.5		120/90	90
21.5-22.5			30/22	40/22	22						91.5-93.5		120/92	92
22.5-23.5			30/23	40/22	23	53.5-55.5	80/54			54	93.5-95.5		120/94	94
23.5-24.5			30/24	40/24	24	55.5-57.5	80/56			56	95.5-97.5		120/96	96
23.5-25.5				40/24	24	57.5-59.5	80/58			58	97.5-99.5		120/98	98
						59.5-61.5	80/60			60	99.5-101.5		120/100	100
						61.5-63.5	80/62			62				
						63.5-65.5	80/64			64				
						65.5-67.5	80/66			66				
						67.5-69.5	80/68			68				
						69.5-71.5	80/70			70				

Blocks are referred to by their width (A) and hole diameter (B). Thus a module with a width of 15 mm and a hole diameter of 4 mm is referred to as 15/4.

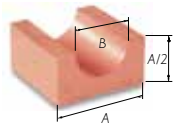

CABLE DIAM.	A (inches)				B	CABLE DIAM.	A (inches)			B	CABLE DIAM.	A (inches)		B
	0.59	0.79	1.18	1.58			1.58	2.36	3.55			3.55	4.73	
0.14-0.18	15/4	20/4			0.16	1.00-1.10	40/26			1.02	2.18-2.26	90/56		2.21
0.18-0.22	15/5	20/5			0.20	1.10-1.16	40/28			1.10	2.26-2.34	90/58		2.29
0.22-0.26	15/6	20/6			0.24	1.16-1.24	40/30			1.18	2.34-2.42	90/60		2.36
0.26-0.30	15/7	20/7			0.28	1.24-1.32	40/32	60/32		1.26	2.42-2.50	90/62		2.44
0.30-0.33	15/8	20/8			0.31	1.32-1.40	40/34	60/34		1.34	2.50-2.58	90/64		2.52
0.33-0.37	15/9	20/9			0.35	1.40-1.48		60/36		1.42	2.58-2.66	90/66		2.60
0.37-0.41		20/10			0.39	1.48-1.55		60/38		1.50	2.66-2.74	90/68		2.68
0.41-0.45		20/11			0.43	1.55-1.63		60/40		1.58	2.74-2.81	90/70		2.76
0.45-0.49		20/12	30/12		0.47	1.63-1.71		60/42		1.65	2.81-2.89		120/72	2.84
0.49-0.53		20/13	30/13		0.51	1.71-1.79		60/44		1.73	2.89-2.97		120/74	2.92
0.53-0.57		20/14	30/14		0.55	1.79-1.87		60/46		1.81	2.97-3.05		120/76	2.99
0.57-0.61			30/15		0.59	1.87-1.95		60/48		1.89	3.05-3.13		120/78	3.07
0.61-0.65			30/16		0.63	1.95-2.03		60/50	90/50	1.97	3.13-3.21		120/80	3.15
0.65-0.69			30/17		0.67	2.03-2.11		60/52	90/52	2.05	3.21-3.29		120/82	3.23
0.69-0.73			30/18		0.71	2.11-2.18		60/54	90/54	2.13	3.29-3.36		120/84	3.31
0.73-0.77			30/19		0.75						3.36-3.44		120/86	3.39
0.77-0.81			30/20		0.79						3.44-3.52		120/88	3.47
0.81-0.85			30/21		0.83						3.52-3.60		120/90	3.55
0.85-0.89			30/22	40/22	0.87						3.60-3.68		120/92	3.62
0.89-0.93			30/23	40/22	0.91	2.11-2.18	80/54			2.13	3.68-3.76		120/94	3.70
0.93-1.00			30/24	40/24	0.95	2.18-2.26	80/56			2.20	3.76-3.84		120/96	3.78
				40/24		2.26-2.34	80/58			2.28	3.84-3.92		120/98	3.86
						2.34-2.42	80/60			2.36				
						2.42-2.5	80/62			2.44				
						2.5-2.58	80/64			2.52				
						2.58-2.66	80/66			2.60				
						2.66-2.74	80/68			2.68				
						2.74-2.81	80/70			2.76				

Blocks are referred to by their width (A) and hole diameter (B). Thus a module with a width of 0.59" and a hole diameter of 0.16" is referred to as 15/4.

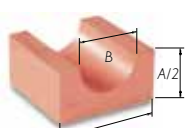

Weight in grams per half							
BLOCK	W	BLOCK	W	BLOCK	W	BLOCK	W
24 x 5/0	58	20/11	13	40/30	42	90/62	239
12 x 10/0	113	20/12	13	40/32	37	90/64	229
15/0	20	20/13	12	40/34	32	90/66	220
20/0	38	20/14	11	60/32	131	90/68	211
30/0	84	30/12	36	60/34	127	90/70	204
40/0	150	30/13	36	60/36	122	120/72	494
60/0	338	30/14	35	60/38	116	120/74	485
90x30/0	279	30/15	34	60/40	110	120/76	472
15/4	10	30/16	33	60/42	104	120/78	462
15/5	10	30/17	31	60/44	98	120/80	448
15/6	10	30/18	30	60/46	91	120/82	437
15/7	10	30/19	28	60/48	84	120/84	425
15/8	9	30/20	27	60/50	77	120/86	415
15/9	8	30/21	25	60/52	59	120/88	403
20/4	18	30/22	24	60/54	61	120/90	385
20/5	18	30/23	22	90/50	287	120/92	368
20/6	17	30/24	21	90/52	279	120/94	360
20/7	17	40/22	57	90/54	273	120/96	351
20/8	16	40/24	54	90/56	262	120/98	332
20/9	15	40/26	50	90/58	255	120/100	313
20/10	14	40/28	47	90/60	243	120/108	243

Weight in oz per half							
BLOCK	W	BLOCK	W	BLOCK	W	BLOCK	W
24 x 5/0	2.0	20/11	0.5	40/30	1.5	90/62	8.4
12 x 10/0	4.0	20/12	0.5	40/32	1.3	90/64	8.1
15/0	0.7	20/13	0.4	40/34	1.1	90/66	7.7
20/0	1.3	20/14	0.4	60/32	4.7	90/68	7.4
30/0	3.0	30/12	1.3	60/34	4.5	90/70	7.2
40/0	5.3	30/13	1.3	60/36	4.3	120/72	17.4
60/0	11.9	30/14	1.2	60/38	4.1	120/74	17.1
90x30/0	9.8	30/15	1.2	60/40	3.9	120/76	16.6
15/4	0.4	30/16	1.2	60/42	3.7	120/78	16.3
15/5	0.4	30/17	1.1	60/44	3.5	120/80	15.8
15/6	0.4	30/18	1.0	60/46	3.2	120/82	15.4
15/7	0.4	30/19	1.0	60/48	3.0	120/84	15.0
15/8	0.3	30/20	1.0	60/50	2.7	120/86	14.6
15/9	0.3	30/21	0.9	60/52	2.4	120/88	14.2
20/4	0.6	30/22	0.8	60/54	2.2	120/90	13.6
20/5	0.6	30/23	0.8	90/50	10.1	120/92	13.0
20/6	0.6	30/24	0.7	90/52	9.8	120/94	12.7
20/7	0.6	40/22	2.0	90/54	9.6	120/96	12.3
20/8	0.6	40/24	1.9	90/56	9.2	120/98	11.7
20/9	0.5	40/26	1.8	90/58	9.0	120/100	11.0
20/10	0.5	40/28	1.7	90/60	8.6	120/108	8.6

# AddBlock

There are eleven different sizes of AddBlock. By tearing off the wing-like inserts, which are of varying thickness, and inserting them in the main block it is possible to accommodate 66 different cable and pipe dimensions, from 3.5 mm (0.14") to 69.5 mm (2.74"). The inserts are fitted with a locating ridge that fits exactly into furrows in the main block. These stop the block from "telescoping".

A seal using AddBlocks is as secure and tight as one using standard blocks. Both types can be combined in a transit, which makes the MCT Brattberg seal system very flexible.

*The AddBlocks basic dimension is given at bottom slot center, and that's the maximum cable dimension the block is designed for.*

*Dimensions are also clearly marked on the four insert sheets. Simply select, tear off and insert.*

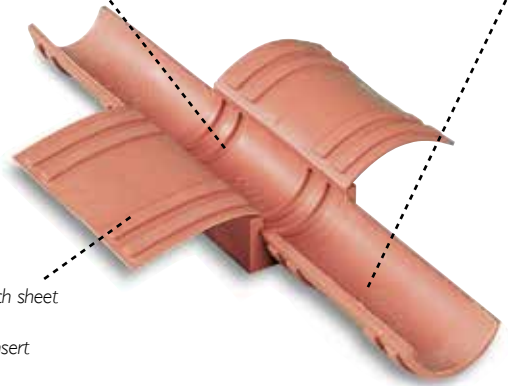

*On the bottom of each sheet you'll find four locking devices to keep the insert in place, making each AddBlock thoroughly secure.*

## Eleven blocks and 66 dimensions

AddBlocks are all the same length as standard Blocks, 60 mm (2.36"). The width of standard Blocks (A measurement, see table) are 20, 30, 40, 60 or 90 mm, (0.79"), (1.18"), (1.57"), (2.36") or (3.54")

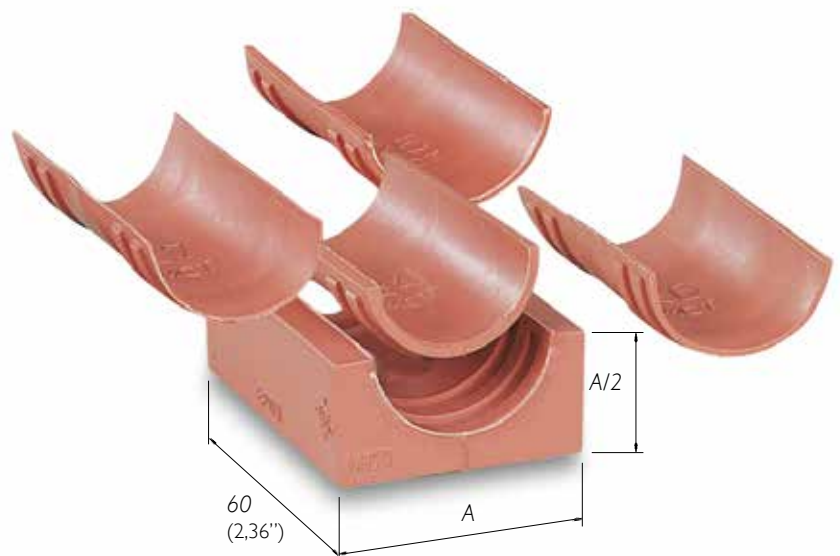





ADDBLOCK DIMENSION	CABLE OR PIPE DIMENSION (mm)	WEIGHT PER HALF (G)	CABLE OR PIPE DIMENSION( inches)	WEIGHT PER HALF (oz)
20/4 - 8	3,5 - 8,5	23	0.14 - 0.33	0.8
20/9 - 13	8,5 - 13,5	23	0.33 - 0.53	0.8
30/14 - 18	13,5 - 18,5	45	0.53 - 0.72	1.6
30/19 - 23	18,5 - 23,5	43	0.72 - 0.93	1.5
40/24 - 28	23,5 - 28,5	71	0.93 - 1.12	2.5
40/29 - 33	28,5 - 33,5	62	1.12 - 1.32	2.2
60/34 - 38	33,5 - 38,5	150	1.32 - 1.52	5.3
60/39 - 43	38,5 - 43,5	136	1.52 - 1.71	4.8
60/44 - 48	43,5 - 49,5	128	1.71 - 1.95	4.5
90/50 - 58	49,5 - 59,5	348	1.95 - 2.34	12.3
90/60 - 68	59,5 - 69,5	318	2.34 - 2.74	11.2

# Plugs and Wraps

The plug's main purpose is to prepare coming installations by creating a spare block together with an AddBlock. Once the cable penetration is to be done, the plug is removed and the AddBlock is reused.

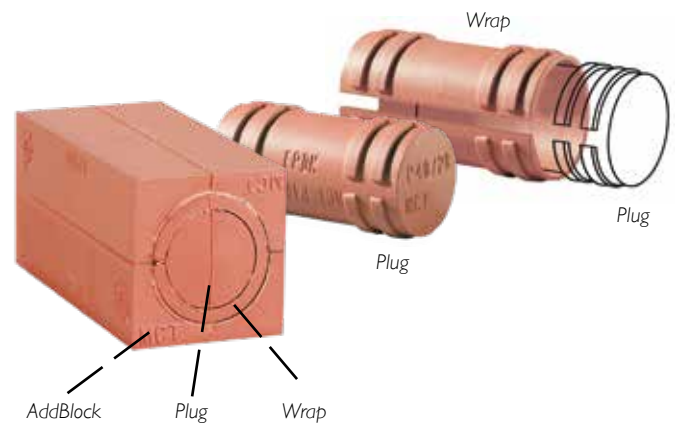

In the table you see which plug, or combination of plug and wrap-around casing, to use when turning an AddBlock into a spare block.

ADDBLOCK	PLUG	WRAP
20/4 - 8	P20/8	
20/9 - 13	P20/8 +	W20/8-13
30/14 - 18	P30/18	
30/19 - 23	P30/18 +	W30/18-23
40/24 - 28	P40-28	
40/29 - 33	P40-28 +	W40/28-33
60/34 - 38	P60/38	
60/39 - 43	P60/38 +	W60/38-43
60/44 - 48	P60/38 +	W60/38-43 and W60/43-48

# X-series cable transit

The MCT Brattberg X-series is a truly unique cable transit system which features an instant SNAP-FIT cable seal designed to accommodate any cable diameter from 2,5mm (0.1") right up to 34,5mm (1.36"), with the flexibility for future expansion of systems within existing frames.

Incorporating a simple staybar securing mechanism, no special tools are required to assemble this ultra-lightweight unit. Because until installation, seals are not subject to any compression, they are sure to stay perfectly shaped and will not suffer from deformation. The unit is sealed prior to cabling, requires no painting and maintenance is kept to an absolute minimum.



## Frames Specification

- Polyester glass filled compression moulding
- UV stabilised material with low smoke
- Ultra low weight
- High strength

## Frames supplied with:

- Compression screws (M6 countersunk head)
- Compression system
- Gasket

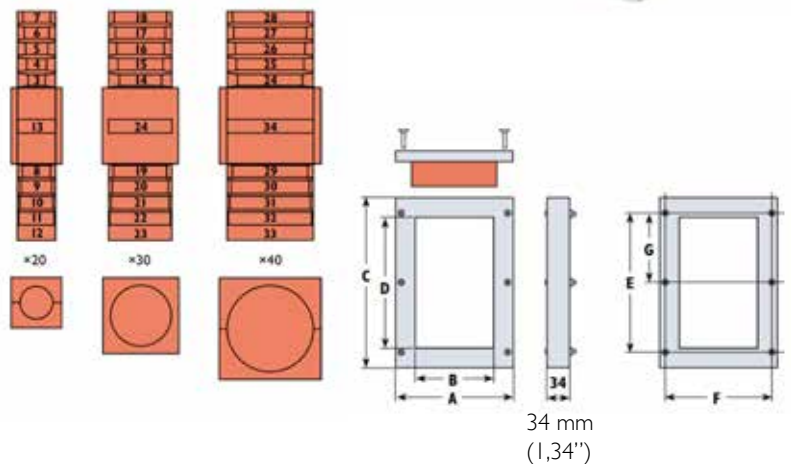

## Staybars

Stainless steel 3 mm (0.12") diameter available in 2 sizes.

**Type 1** 120 mm (4.72") long ref SB 120

**Type 2** 60 mm (2.36") long ref SB 60

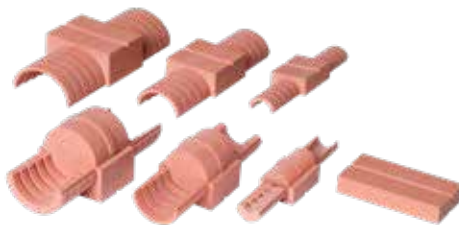

## Sizes

Type	A	B	C	D	A	B	C	D
	mm				Inches			
X1	178	120	260	200	7.01	4.72	10.24	7.87
X2	118	60	210	150	4.65	2.36	8.27	5.91

N.B multiple frames are available. Details on request.

Block sizes	E	F	G	E	F	G
	mm			Inches		
X20/3-13	20	10	2,5-13,5	0.79	0.39	0.1 - 0.53
X30/14-24	30	15	13,5-24,5	1.18	0.59	0.53-0.96
X40/24-34	40	20	23,5-34,5	1.57	0.79	0.93 - 1.36

N.B sold as complete modules (2 halves & Plug)

## Fixing Hole Dimensions

Type	E	F	G	E	F	G
	mm			Inches		
X1	215	160	107,5	8.46	6.3	4.23
X2	118	60	210	5.12	3.46	8.27

N.B sold as complete modules (2 halves & Plug)

# ALF-Cabinet seal

ALF cabinet seal is a cable penetration for applications where dust- and water tightness are demanded. A lot of cables can be installed in a small area and the big opening even allows connectors and joints to pass through.

The cables are individual sealed off with 30 mm (1.18") insert blocks which comes in the same sizes as MCT Brattberg Standard Blocks, AddBlocks and HandiBlocks. ALF is compressed with two bolts and a standard allen key. The seal is easy to open up for changing or completion of cables.

## Advantages

- All cables through one opening (also with connector)
- Available as EMC
- Many cables in a limited area
- Specifications of cable sizes are no problem
- Easy changing/adding cables afterwards
- Dust- and waterproof (IP67)
- Assembly without special tools
- For cables with diameters from 3- 54 mm (0.12 – 2.13")
- Supplied complete with gasket, bolts and nuts
- Tested and approved



The frames are available in several different sizes

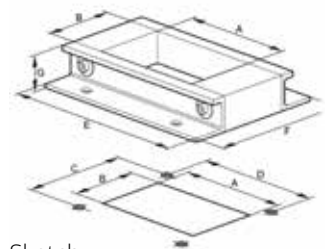

Sketch



## Performances

- Aluminum (standard) or stainless steel
  - Standard dimensions or custom
  - Supplied complete with gaskets, nuts and bolts
- Available certifications
- IP 67 according to IEC / EN 60529
  - UL 50 test certificate
  - UL94 test certificate (approved for Class V0)
  - NEMA, Type 3R and 4X & 12

Completion of cables.

ALF is available in aluminium or stainless steel and is always supplied in kit form with gasket, bolts and nuts.

Classified according to:

UL 94 VO UL50 NEMA 3R & 4X & 12

Enclosure IP 66 / IP 67

Also custom sizes available!

## Table

Size Length (mm)	Width (mm)	Weight (kg)
ALF 60	40	0,50
ALF 90	40	0.54
ALF 90x2	40	1.0
ALF 120	40	0.59
ALF 120x2	40	1.1
ALF 150	40	0.62
ALF 150x2	40	1.14
ALF 90+90	40	0,95
ALF 90+90x2	40	1.52
ALF 120+120 (240)	40	1.04
ALF 120+120x2 (240x2)	40	1.67
ALF 150+150 (300)	40	1.15
ALF 150+150x2 (300x2)	40	2.00

Size Length (mm)	Width (mm)	Weight (kg)
ALF 60	60	0.60
ALF 90	60	0.634
ALF 90x2	60	1.093
ALF 120	60	0.686
ALF 120x2	60	1.175
ALF 150	60	0.717
ALF 150x2	60	1.24
ALF 90+90	60	1.04
ALF 90+90x2	60	1.615
ALF 120+120 (240)	60	1.135
ALF 120+120x2 (240x2)	60	1.763
ALF 150+150 (300)	60	1.1
ALF 150+150x2 (300x2)	60	2.096

# RFCS-Cabinet seal

The unique MCT Brattberg RFCS is available in three basic sizes of 10, 12 & 16 with an extension provision to size 20, 24 & 32 respectively. Is an innovative openable/ retrofit alternative to heavy duty plug in connectors and cable glands plates in the cabinets.

MCT Brattberg RFCS frame provides:  
Space saving frames compare to conventional plug in connectors & cable glands. Unique MCT Brattberg compression wedge PTG40 that can be inserted from both sides of the frame.  
Easy installation and availability with ready made packed kits including the sealing module as per customer requirements.  
Classifications: IP65, IP67 and NEMA 250 type 4x (hose down)



## MCT Brattberg RFCS Kit contains:

- Openable frame.
- RFCS modules marked with cable diameter.
- Compression wedge.
- Gasket for sealing frame to cabinet.
- Mounting Hardware.
- Installation Manual.
- Lubricant.

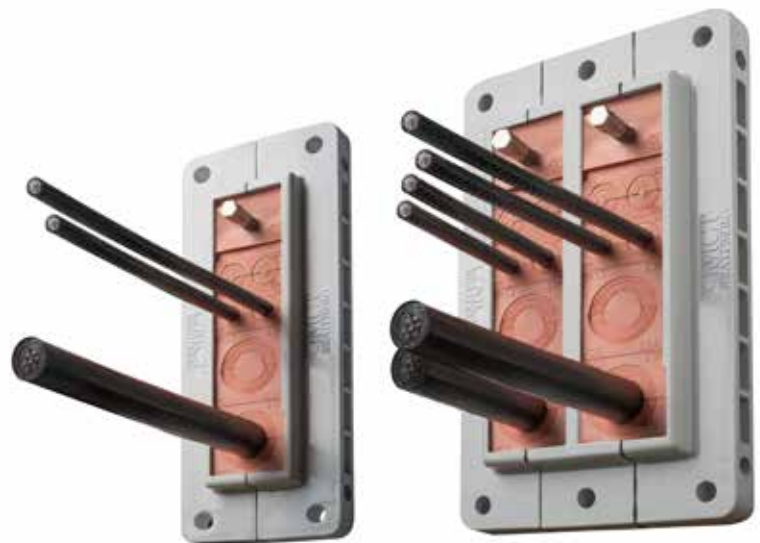

## Data

Modules: EPDM

## Aluminium:

Grade ADC-12

## Gasket between frame and cabinet:

EPDM

## Gasket between frame halves:

EPDM

## Plastic gasket washer:

LDPE

## Mounting hardware:

SS-304

EPDM is Halogen Free and Low smoke.

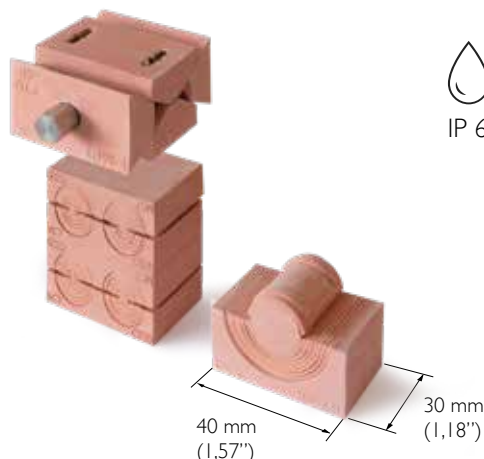

	Diameter range		Required cut out mm	Packing space mm	Diameter range		Required cut out inches	Packing space inches
	2,5-16,0 mm	14,5-33,0 mm			0,1-0,63 inches	0,57-1,3 inches		
<b>RFCS 10</b>	Number of cables				Number of cables			
RFCS 10/4	2	2	55x145	100x40	2	2	2.17x5.71	3.94x1.57
RFCS 10/7	6	1	55x145	100x40	6	1	2.17x5.71	3.94x1.57
RFCS 10/10	10	0	55x145	100x40	6	1	2.17x5.71	3.94x1.57
<b>RFCS 12</b>	Number of cables				Number of cables			
RFCS 12/3	0	3	55x165	120x40	0	3	2.17x6.5	4.72x1.57
RFCS 12/6	4	2	55x165	120x40	4	2	2.17x6.5	4.72x1.57
RFCS 12/9	8	1	55x165	120x40	8	1	2.17x6.5	4.72x1.57
RFCS 12/12	12	0	55x165	120x40	12	0	2.17x6.5	4.72x1.57
<b>RFCS 16</b>	Number of cables				Number of cables			
RFCS 16/4	0	4	55x205	160x40	0	4	2.17x8.07	6.3x1.57
RFCS 16/7	4	3	55x205	160x40	4	3	2.17x8.07	6.3x1.57
RFCS 16/10	8	2	55x205	160x40	8	2	2.17x8.07	6.3x1.57
RFCS 16/13	12	1	55x205	160x40	12	1	2.17x8.07	6.3x1.57
RFCS 16/16	16	0	55x205	160x40	16	0	2.17x8.07	6.3x1.57
<b>RFCS 20</b>	Number of cables				Number of cables			
RFCS 20/8	4	4	100x145	200x40	4	4	3.94x5.71	7.87x1.57
RFCS 20/14	12	2	100x145	200x40	12	2	3.94x5.71	7.87x1.57
RFCS 20/20	20	0	100x145	160x40	20	0	3.94x5.71	7.87x1.57
<b>RFCS 24</b>	Number of cables				Number of cables			
RFCS 24/6	0	4	55x205	160x40	0	4	2.17x8.07	6.3x1.57
RFCS 24/12	4	3	55x205	160x40	4	3	2.17x8.07	6.3x1.57
RFCS 24/18	8	2	55x205	160x40	8	2	2.17x8.07	6.3x1.57
RFCS 24/24	12	1	55x205	160x40	12	1	2.17x8.07	6.3x1.57
<b>RFCS 32</b>	Number of cables				Number of cables			
RFCS 32/8	0	8	100x205	320x40	0	8	3.94x8.07	12.6x1.57
RFCS 32/14	8	6	100x205	320x40	8	6	3.94x8.07	12.6x1.57
RFCS 32/20	16	4	100x205	320x40	16	4	3.94x8.07	12.6x1.57
RFCS 32/26	24	2	100x205	320x40	24	2	3.94x8.07	12.6x1.57
RFCS 32/32	32	0	100x205	320x40	32	0	3.94x8.07	12.6x1.57

RFCS 10

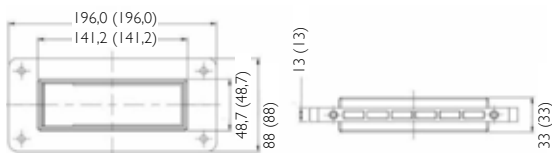

RFCS 20

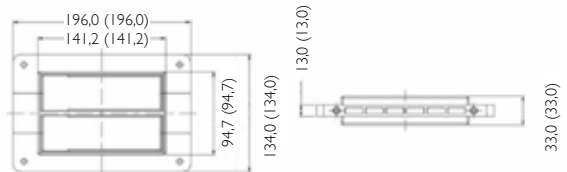

RFCS 12

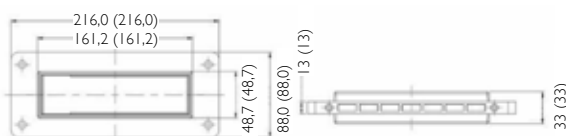

RFCS 24

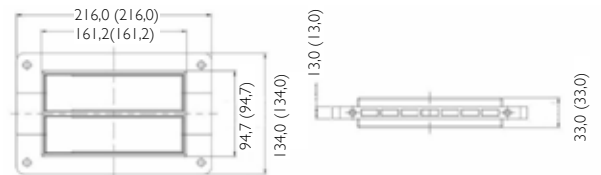

RFCS 16



RFCS 32

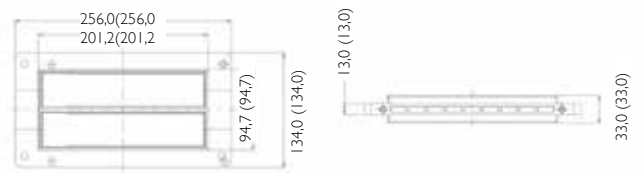



# Transits for Rolling Stock



Putting  
safety first

# Tailor made transits for the rolling stock.

Since the early 1950s, when we first started specializing in fireproof and pressure-sealed transits, quality testing and classification has been essential. The MCT Brattberg is a complete sealing system for

cable and pipe transits designed to allow penetration with a high level of security. The MCT Brattberg transits are designed to protect passengers and keeping equipment safe from harm.

---

## MCT Brattberg transits features:

IP 65, 66, 67, 68 acc. to IEC 60529

Type 3R, 4X, 12 acc. to NEMA 250

HL3,2,1 for R22 & R23 acc. to EN-45545-2

EI30 & E60 acc. EN-45545-3

EN 15085-2

ISO 3834-2

## Benefits:

- Always marked cable dimensions on the modules.
- Fast assembly
- Lightweight and low-profile
- No decision-making by installer
- Approved for all the parts of the train.
- Can be dismantled and re-used.
- Flexible modules available.
- Fixed modules available for fast production assembly.
- Welding and bolting.
- Steel, Stainless steel or aluminum.

## References:

### On Train

Examples of MCT Transit systems in Undergrounds:

In London (England), Rosy (France), San Fransisco (USA), Lausanne (Schweiz), Caracas (Venezuela), Nanjung (China), Paris (France) Taipei (Taiwan), Cicago (USA), Turin (Italy) Chech republic., Caracas, Nanjing, Shanghai

### Examples of MCT Transit systems in Motor Coaches:

IDF coaches, TGV Duplex coaches, Prima 6000 coaches, BB 36000 coaches, TGV PBA & PBKA coaches, TGV Eurostar

### Examples of MCT Transit systems in High-speed Trains (TGV):

France Duplex TGV, Korea KTX TGV, PBA & PBKA Thalys TGV, Eurostar transmanche TGV, TGV network

### Examples of MCT Brattberg Transit systems in Regional Express Trains:

AGC, TER 2N New Generation, A-TER x-40, Z-TER, A-TER, ALR Bordline, ALR-CFL, M1 2N

### Examples of MCT Brattberg Transit systems in Trams:

Strasbourg (France), Mestre-Venise (Italy), Trams Clermont-Ferrand (France),

For more references visit our website:  
[www.mctbrattberg.com](http://www.mctbrattberg.com)





We help you adapt our transits with the technical demands and designs you require. Contact us to book a personal meeting or ask us a question about transits in the rolling stock.

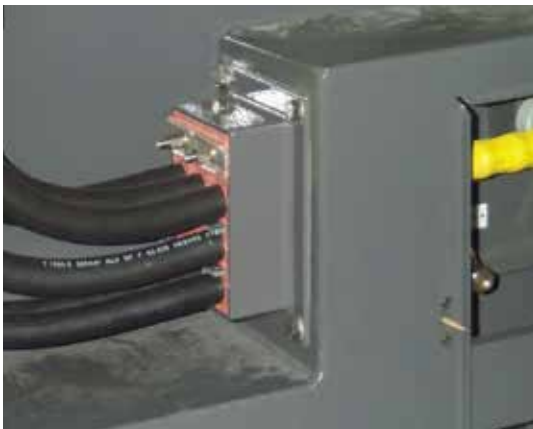



# E-Series

For EMC, Lightning, Grounding and Bonding



Putting  
safety first



# Product program

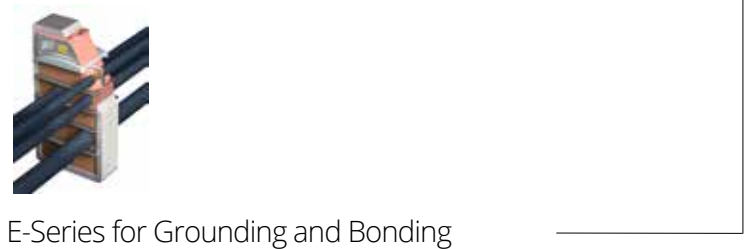
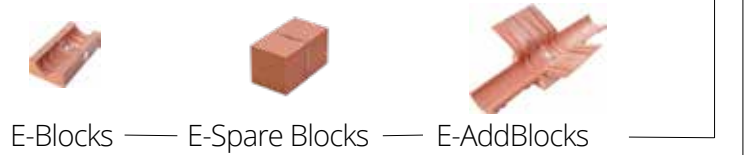
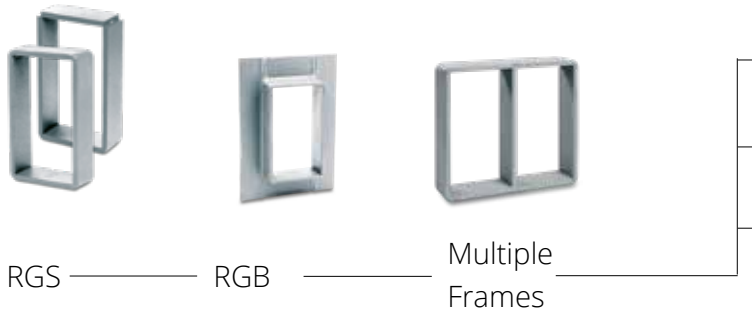

Hazardous environments	Page 4
E-MCT Brattberg system	Page 5
Design, Test and Quality	Page 6
RGS	Page 8
RGB	Page 10
Multiple Frames	Page 12
E-RGP for Round Penetrations	Page 13
Sleeves	Page 13
Components / Accessories	Page 14
Planning Packing Space	Page 15
E-Blocks, E-Spare Blocks	Page 16
E-AddBlocks	Page 18
E-Series for Grounding and Bonding	Page 19
Packing Plan	Page 22

## MCT Brattberg seals cable and pipe penetrations in potentially Hazardous environments

Cable and Pipe Penetrations exist whenever services are routed through walls, floor, decks or bulkheads. In an emergency situation these penetrations could allow the passage of hazardous such as fire, water and gas.

The unique MCT Brattberg System has been approved by all leading Marine and Civil Authorities as a certified method of sealing such penetrations.

The MCT Brattberg system is a Multipurpose seal designed to allow penetration without compromising the security of the construction. Each and every cable and pipe is lead through a frame by its own pair of halogen free module blocks which are then sealed by the use of a compression system.

The E-MCT seal system in addition to all benefits of the MCT system the specific E-MCT seal system provide protection against electromagnetic pulses, electronic sabotage and static electricity.



### **Necessity for protection**

With the growing dependence on computers, communication and control equipment the problem of sensitivity to interference becomes more apparent, given the vulnerability of modern electronic equipment.

The vulnerability can lead to expensive interruptions in production, communication and process control. Consequently, it is essential that two of the most important concerns with modern electronics must be to create a safe and secure environment and to eliminate the risk of interference.

# The MCT Brattberg E-Series

Since the early 1950s, when we first started specializing in fireproof and pressure-sealed transits, quality testing and classification has been essential.



Historically, protection of buildings, personnel and equipment from lightning was achieved by the use of lightning conductors. These measures, however, are inadequate as they provide protection from fire and personal injury only; to eliminate the Electromagnetic Interference (EMI), sometimes known as electronic smog, protection must be more specific. The protection is achieved by a means known as Electromagnetic Compatibility (EMC) giving both external and internal interference protection. The MCT Brattberg system is available in a specific E-version which include both the EMI and EMC- version. Around and in close proximity to every electrical conductor exist a magnetic field. This magnetic field generates/interferes with the current flow, known as induction.

Such induction fields can easily cause important information to be destroyed and, in extreme cases, affect the electronic equipment.

The ability of any cable to intercept such energy depends on how and where it is installed, on its connection to other units and on its construction. The cables screening properties, therefore depend closely on the cable shielding. The cable screen is able to dissipate and absorb magnetic interference fields, therefore protecting its core conductor. These electromagnetic interference pulses can be discharged from screen to earth.

The MCT E-Series contains a sprung copper sheet which prevents transfer of interference in the cable. Consequently, every MCT E-Transit also works as an extended wall screen.

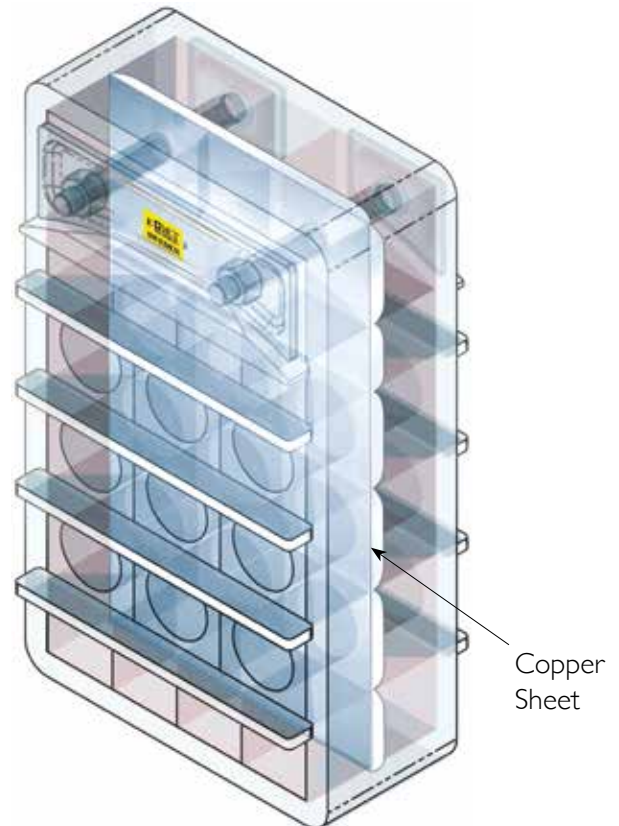

## Benefits of MCT Brattberg E-systems

- Pre-lubricated insert blocks for faster installation with assured continuity.
- Protects against electrical and magnetic interference (EMI), "bugging", electronic sabotage (SEMP) and static electricity (ESD).
- Assists cable management.
- Integral earthing between cables and wall screen.
- Also seals the penetration against the passage of fire, water, gas, sound and environmental hazards.
- Special E-Series for Grounding and Bonding (cables up to max. 1AWG)

# Design

As with all MCT Brattberg products, the MCT Brattberg E-system comprises of a modular sealing system installed in a frame and sealed by compression system. Uniquely, however, the MCT E-system contains features which ensure earth continuity and screening through the penetration. Frames are welded into the wall structure to give earth bonding. For round penetrations a steel sleeve is welded to the structure prior to the installation of the RGP transit. (see page 13.)

MCT E-Blocks have the facility to screen and earth cables and pipes when installed in such frames. Stayplates are used to key blocks into frames and aid continuity between module blocks. The compression plate and E-STG endpacker whilst compressing the system, give the facility to allow full screen and earthing bond. (Alternatively compression is with the E-PTG Presswedge, see page 14).

The E-MCT blocks consists of 2 different materials:  
- The special developed rubber material Lycron is halogen free, prelubricated and gives the advantages of fire resistance, low smoke emission, heat insulation an excellent chemical resistance.  
- The integral copper sheet allows the discharging and shielding protection between the cable and the system. In order to achieve continuity approximately 10 mm (0.39") of the outer cable insulation must be removed (see photo). The exposed braiding must be placed in the centre of the insert block.

## DISCLAIMER

*The author and publisher of this catalogue intend that this catalogue contain only general discussions and information; it is not intended to be comprehensive or to address all the possible contexts and situations involving the products and processes described herein. This catalogue is designed for generic study or research use only and is not a substitute for specific training or experience when utilizing the products and processes discussed herein. Nor is this catalogue intended to serve as a substitute for any proper training and/or certification needed for operation of the products and processes described herein. Accordingly, this catalogue is meant to be advisory and is not intended for specific application. Each application of the products and/or processes described herein may differ and the specifics involved must be addressed separately and individually depending on your situation.*

*MCT Brattberg (the "Company") assumes no liability for any use of or reliance upon any material contained or referenced in this catalogue; the use of this catalogue is at your own risk. THE*



*COMPANY MAKES NO WARRANTIES, EXPRESS OR IMPLIED, INCLUDING WARRANTIES AS TO MERCHANTABILITY, AS TO THE FITNESS OF THE CATALOGUE OR ITS CONTENTS FOR ANY PARTICULAR USE OR PURPOSE, NON-INFRINGEMENT, OR AS TO THE ACCURACY, APPLICABILITY, OR COMPLETENESS OF THE CONTENTS OF THE CATALOGUE, AND SHALL NOT BE LIABLE FOR ANY LOSS OR DAMAGE, DIRECTLY OR INDIRECTLY, ARISING FROM THE USE OF SUCH CATALOGUE OR FOR CONSEQUENTIAL DAMAGES. In no event shall Company be liable for: (a) punitive, incidental or consequential damages arising out of the use of the information from this catalogue, including, but not limited to, damage to persons or property, loss of use, loss of time, inconvenience, equipment rental, loss of earnings or profits, loss of business opportunities, or any other commercial loss, or (b) any losses, claims, damages, expenses, liabilities or costs (including legal fees) resulting directly or indirectly from use of the material in this CATALOGUE, WHICH IS PROVIDED "AS IS," AND WITHOUT WARRANTIES. The conditions in this paragraph apply to any acts, omissions and negligence of Company that would give rise to a course of legal action. The reader hereby agrees to indemnify and hold harmless Company its officers, directors, shareholders, employees, agents, subsidiaries, affiliates, parent companies and successors in interest against all claims and expenses (including attorney fees) arising from the use of any information in the catalogue. Further, Company is not responsible for any warranties of any nature made by any representative or agent that have not also been agreed to in writing by an officer of the Company.*

364 - 388174v1 056390100001



# Tested, approved and certified

Since the early 1950s, when we first started specializing in fireproof and pressure-sealed transits, quality testing and classification has been essential.

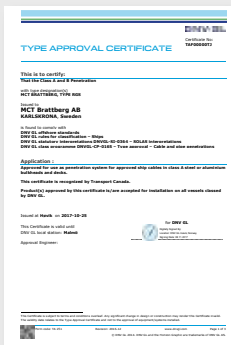

EMC tested by  
 FFV (Research Institute for the Swedish National Defence), Sweden  
 Karlskrona Shipyard, Sweden  
 Saab Avionics AB, Sweden  
 IRD Aish & Co Ltd, UK  
 LPC H120 Firetest, UK  
 Siemens AG Research Centre, Germany

In 1986 our sealing method and quality system was adapted to meet the rigid requirements of the offshore industry. and have been continuously to current requirements.

Today MCT Brattberg is assessed and certified by DNV, in accordance with the Quality and Environment Management system standard EN ISO 9001 and 14001, for the design, manufacture and supply of fire barrier and sealed transit systems associated with cable and pipe routes in building and marine environments. As a direct result of this achievement, quality and environmental assessments are carried out by DNV twice annually.

## Our products are tested and certified by a long list of customers, laboratories and certification organizations.

ABS, American Bureau of Shipping - Canadian Coast Guard - Bureau Veritas - China Classification Society - Australian Maritime Safety Authority - DNV, Det Norske Veritas - Korean Register of Shipping - Lloyds' Register of Shipping - Nippon Kaiji Kyokai - Polski Rejestr Statkow - Germanischer Lloyd - Swedish Adm. of Shipping and Navigation - Croatian Register of Shipping - RINA, Registro Italiano Navale - Russian Maritime Register - US Coast Guard - US Navy - Underwriters Laboratories Inc. Underwriters Laboratories of Canada

MCT Brattberg is also certified according to MED, Marine Equipment Directive (via Lloyds' Register of Shipping)

Please consult MCT Brattberg for latest updated certificates and approvals.

# RGS

## RGSO with removable end

RGS is MCT Brattberg's standard frame for marine applications. It has a standard internal width of 120 mm (4.72") and is 60 mm (2.36") deep. There are four sizes of RGS, denoted by 2, 4, 6 and 8 depending on their height. They may be used in both vertical and/or horizontal multiple frames (see page 12).

The RGS is welded into an accurately pre-cut hole in the deck or bulkhead. As with all our frames, RGS is produced in steel, stainless steel or aluminium. For installations where cables are already in place, specify RGSO, which has a removable end. RGS weight charts can be found on the next page.



Frame size	Size in mm								Size in inches											
	H	W (width) Multiple Frames							H	W (width) Multiple Frames										
	x 1	x 2	x 3	x 4	x 5	x 6	x n		x 1	x 2	x 3	x 4	x 5	x 6	x n					
RGS-2	121	140,5	271	401,5	532	662,5	793	4.76	5.53	10.67	15.81	20.94	26.08	31.2	W =					
RGS-4	179,5	-	-	-	-	-	-	7.07	-	-	-	-	-	-	0.40+					
RGS-6	238	-	-	-	-	-	-	9.37	-	-	-	-	-	-	5.14					
RGS-8	296,5	-	-	-	-	-	-	11.67	-	-	-	-	-	-	x n					
RGS-2+2	242	-	-	-	-	-	-	9.53	-	-	-	-	-	-	-					
RGS-2+4	300,5	-	-	-	-	-	-	11.83	-	-	-	-	-	-	-					
RGS-2+6	359	-	-	-	-	-	-	14.13	-	-	-	-	-	-	-					
RGS-2+8	417,5	-	-	-	-	-	-	16.44	-	-	-	-	-	-	-					
RGS-4+4	359	-	-	-	-	-	-	14.13	-	-	-	-	-	-	-					
RGS-4+6	417,5	-	-	-	-	-	-	16.44	-	-	-	-	-	-	-					
RGS-4+8	476	-	-	-	-	-	-	18.74	-	-	-	-	-	-	-					
RGS-6+6	476	-	-	-	-	-	-	18.74	-	-	-	-	-	-	-					
RGS-6+8	534,5	-	-	-	-	-	-	21.04	-	-	-	-	-	-	-					
RGS-8+8	593	-	-	-	-	-	-	23.35	-	-	-	-	-	-	-					
RGS-2+2	232	140,5	n = number of frames wide. Tolerance single frame: Height ± 1 mm Width ± 0,8 mm Material thickness is 10 mm					9.13	5.53	n = number of frames wide. Tolerance single frame: Height ± 0.04", Width ± 0.03". Material thickness is 0.39".										
RGS-2+4	290,5	-						-	-								-	-	11.44	-
RGS-2+6	349	-						-	-								-	-	13.74	-
RGS-2+8	407,5	-						-	-								-	-	16.04	-
RGS-4+4	349	-						-	-								-	-	13.74	-
RGS-4+6	407,5	-						-	-								-	-	16.04	-
RGS-4+8	466	-						-	-								-	-	18.35	-
RGS-6+6	466	-						-	-								-	-	18.35	-
RGS-6+8	524,5	-						-	-								-	-	20.65	-
RGS-8+8	583	-						-	-								-	-	22.95	-

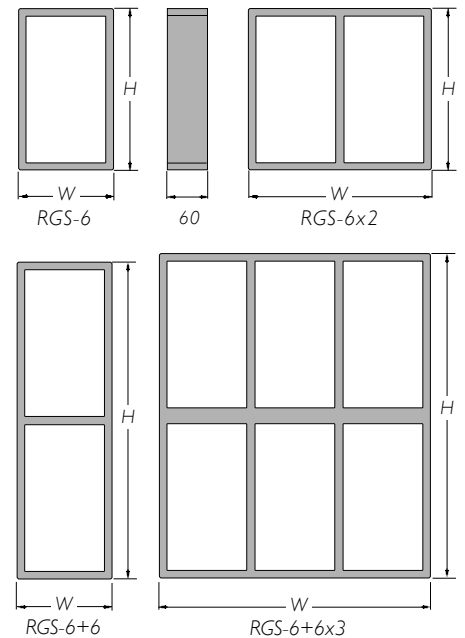

## WEIGHT CHART

Standard frames come in four sizes: 2, 4, 6 and 8. They are all the same width. Height differences are shown below. The material is 10 mm (0.39") thick.

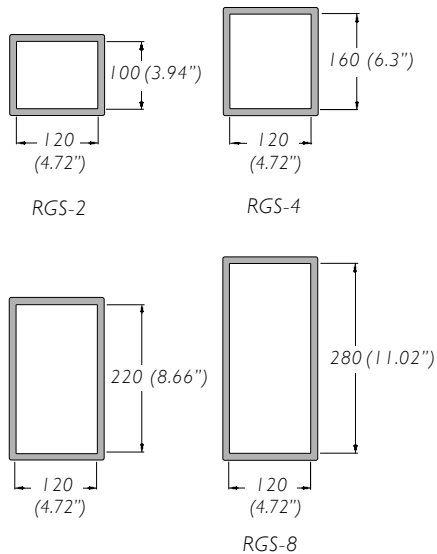

Material	Frame size	Weight in kilograms						Weight in pounds						
		W (width) Multiple Frames						W (width) MultipleFrames						
		x1	x2	x3	x4	x5	x6	x1	x2	x3	x4	x5	x6	
MILD STEEL	RGS-2	2,2	3,9	5,7	7,4	9,2	10,9	4,9	8,6	12,6	32,6	20,3	24,0	
	RGS-4	2,7	4,6	6,5	8,4	10,3	12,2	6,0	10,1	14,3	37,3	22,7	26,9	
	RGS-6	3,2	5,4	7,6	9,8	12,0	14,2	7,1	11,9	16,8	41,0	26,5	31,3	
	RGS-8	3,8	6,3	8,9	11,4	14,0	16,5	8,4	13,9	19,6	44,8	30,9	36,4	
	S355JR S355J2 S355K2	RGS-2+2	3,6	8,1	11,9	15,7	19,5	23,3	7,9	17,9	26,2	52,9	43,0	51,4
		RGS-2+4	4,2	8,8	12,8	16,7	20,7	24,6	9,3	19,4	28,2	56,7	45,6	54,2
		RGS-2+6	4,8	9,5	13,6	17,8	21,9	26,0	10,6	20,9	30,0	60,0	48,3	57,3
		RGS-2+8	5,5	10,3	14,7	19,1	23,5	27,9	12,1	22,7	32,4	64,4	51,8	61,5
	A36 AH36 DH36 EH36	RGS-4+4	4,8	9,5	13,6	17,8	21,9	26,0	10,6	20,9	30,0	60,0	48,3	57,3
		RGS-4+6	5,5	10,3	14,7	19,1	23,5	27,9	12,1	22,7	32,4	64,4	51,8	61,5
RGS-4+8		5,9	11,1	15,8	20,5	25,1	29,8	13,0	24,5	34,8	68,3	55,3	65,7	
RGS-6+6		5,9	11,1	15,8	20,5	25,1	29,8	13,0	24,5	34,8	68,3	55,3	65,7	
	RGS-6+8	6,5	12,0	17,0	22,1	27,1	32,1	14,3	26,5	37,5	73,0	59,7	70,8	
	RGS-8+8	7,2	12,9	18,3	23,7	29,1	34,5	15,9	28,4	40,3	78,0	64,2	76,1	
STAINLESS STEEL 1.4404 AISI 316L	RGS-2	2,2	4,0	12,1	7,6	9,4	11,2	4,9	8,8	12,8	33,5	20,7	24,7	
	RGS-4	2,8	4,7	13,9	8,6	10,6	12,6	6,2	10,4	14,8	38,1	23,4	27,8	
	RGS-6	3,3	5,5	15,4	10,0	12,3	14,5	7,3	12,1	17,2	41,9	27,1	31,7	
	RGS-8	3,9	6,5	16,9	11,7	14,3	16,9	8,6	14,3	20,1	45,9	31,5	37,3	
		RGS-2+2	3,7	8,3	19,5	16,1	20,0	23,9	8,2	18,3	26,9	54,5	44,1	52,7
		RGS-2+4	4,3	9,0	21,0	17,1	21,2	25,2	9,5	19,8	28,9	58,2	46,7	55,6
		RGS-2+6	4,9	9,7	22,4	18,2	22,5	26,7	10,8	21,4	30,9	61,5	49,6	58,9
		RGS-2+8	5,6	10,6	24,2	19,6	24,1	28,6	12,3	23,4	33,3	65,9	53,1	63,1
		RGS-4+4	4,9	9,7	22,4	18,2	22,5	26,7	10,8	21,4	30,9	61,5	49,6	58,9
		RGS-4+6	5,6	10,6	24,2	19,6	24,1	28,6	12,3	23,4	33,3	65,9	53,1	63,1
		RGS-4+8	6,0	11,4	25,8	21,0	25,8	30,6	13,2	25,1	35,7	70,1	56,9	67,5
		RGS-6+6	6,0	11,4	25,8	21,0	25,8	30,6	13,2	25,1	35,7	70,1	56,9	67,5
		RGS-6+8	6,7	12,3	27,5	22,6	27,8	32,9	14,8	27,1	38,6	74,7	61,3	72,5
		RGS-8+8	7,4	13,2	29,5	24,3	29,9	35,4	16,3	29,1	41,4	80,0	65,9	78,0
ALUMINIUM EN AW-6082 EN AW-5086	RGS-2	0,8	1,4	4,1	2,6	3,2	3,8	1,8	3,1	4,4	11,5	7,1	8,4	
	RGS-4	1,0	1,6	4,8	3,0	3,6	4,3	2,2	3,5	5,1	13,0	7,9	9,5	
	RGS-6	1,1	1,9	5,3	3,4	4,2	5,0	2,4	4,2	6,0	14,3	9,3	11,0	
	RGS-8	1,3	2,2	5,8	4,0	4,9	5,8	2,9	4,9	6,8	15,7	10,8	12,8	
		RGS-2+2	1,3	2,8	6,7	5,5	6,9	8,2	2,9	6,2	9,3	18,5	15,2	18,1
		RGS-2+4	1,5	3,1	7,2	5,9	7,2	8,6	3,3	6,8	9,9	20,1	15,9	19,0
		RGS-2+6	1,7	3,3	7,7	6,2	7,7	9,1	3,7	7,3	10,6	21,2	17,0	20,1
		RGS-2+8	1,9	3,6	8,3	6,7	8,3	9,8	4,2	7,9	11,5	22,5	18,3	21,6
		RGS-4+4	1,7	3,3	7,7	6,2	7,7	9,1	3,7	7,3	10,6	21,2	17,0	20,1
		RGS-4+6	1,9	3,6	8,3	6,7	8,3	9,8	4,2	7,9	11,5	22,5	18,3	21,6
		RGS-4+8	2,1	3,9	8,8	7,2	8,8	10,4	4,6	8,6	12,1	24,0	19,4	22,9
		RGS-6+6	2,1	3,9	8,8	7,2	8,8	10,4	4,6	8,6	12,1	24,0	19,4	22,9
		RGS-6+8	2,3	4,2	9,4	7,7	9,5	11,2	5,1	9,3	13,2	25,6	20,9	24,7
		RGS-8+8	2,5	4,5	10,0	8,3	10,2	12,1	5,5	9,9	14,1	27,3	22,5	26,7

# RGB

## RGBO with removable end

RGB is MCT Brattbergs standard frame for embedment or built-in. For EMC protection the frame shall be welded into the wall structure or to a facing plate to get earth bounding. RGB comes in four different sizes, in varying height and designates RGB-2, RGB-4, RGB-6 and RGB-8. The width dimension is always the same, 120 mm (4,72"), as well as the depth 60 mm (2,36"). The frame profiles width are 60 mm (2,36") and the thickness of the material is 6 mm (0,24"). For installations where cables already are in place the RGBO frame with openable gable is used. More information about combination frames can be found on page 12.



Size in mm (Size in inches)																
H W (width) Combination frames																
FRAME SIZE		x 1	x 2	x 3	x 4	x 5	x 6		(height)	x 1	x 2	x 3	x 4	x 5	x 6	x n
RGB/RGG-2	221	240.5	371	501.5	632	762.5	893	W=110+	8.7	9.47	10.67	19.74	24.88	30.2	35.16	W+4.33
RGB/RGG-4	279.5	- "-	- "-	- "-	- "-	- "-	- "-	130.5 x n	11.0	- "-	- "-	- "-	- "-	- "-	- "-	+5.14
RGB/RGG-6	338	- "-	- "-	- "-	- "-	- "-	- "-		13.31	- "-	- "-	- "-	- "-	- "-	- "-	x n
RGB/RGG-8	396.5	- "-	- "-	- "-	- "-	- "-	- "-		15.61	- "-	- "-	- "-	- "-	- "-	- "-	
RGB/RGG-2+2	332	- "-	- "-	- "-	- "-	- "-	- "-		13.07	- "-	- "-	- "-	- "-	- "-	- "-	
RGB/RGG-2+4	390.5	- "-	- "-	- "-	- "-	- "-	- "-		15.37	- "-	- "-	- "-	- "-	- "-	- "-	
RGB/RGG-2+6	449	- "-	- "-	- "-	- "-	- "-	- "-		17.68	- "-	- "-	- "-	- "-	- "-	- "-	
RGB/RGG-2+8	507.5	- "-	- "-	- "-	- "-	- "-	- "-		19.98	- "-	- "-	- "-	- "-	- "-	- "-	
RGB/RGG-4+4	449	- "-	- "-	- "-	- "-	- "-	- "-		17.68	- "-	- "-	- "-	- "-	- "-	- "-	
RGB/RGG-4+6	507.5	- "-	- "-	- "-	- "-	- "-	- "-		19.98	- "-	- "-	- "-	- "-	- "-	- "-	
RGB/RGG-4+8	566	- "-	- "-	- "-	- "-	- "-	- "-		22.28	- "-	- "-	- "-	- "-	- "-	- "-	
RGB/RGG-4+6	566	- "-	- "-	- "-	- "-	- "-	- "-		22.28	- "-	- "-	- "-	- "-	- "-	- "-	
RGB/RGG-6+8	624.5	- "-	- "-	- "-	- "-	- "-	- "-		24.59	- "-	- "-	- "-	- "-	- "-	- "-	
RGB/RGG-4+8	683	- "-	- "-	- "-	- "-	- "-	- "-		26.89	- "-	- "-	- "-	- "-	- "-	- "-	

n = number of frames in width.

Tolerances single frame:

3.5 mm (0,14").

Thickness of material 6 mm

(0,24") except for internal horizontal and vertical walls in combination frames such as 10 mm (0,39").

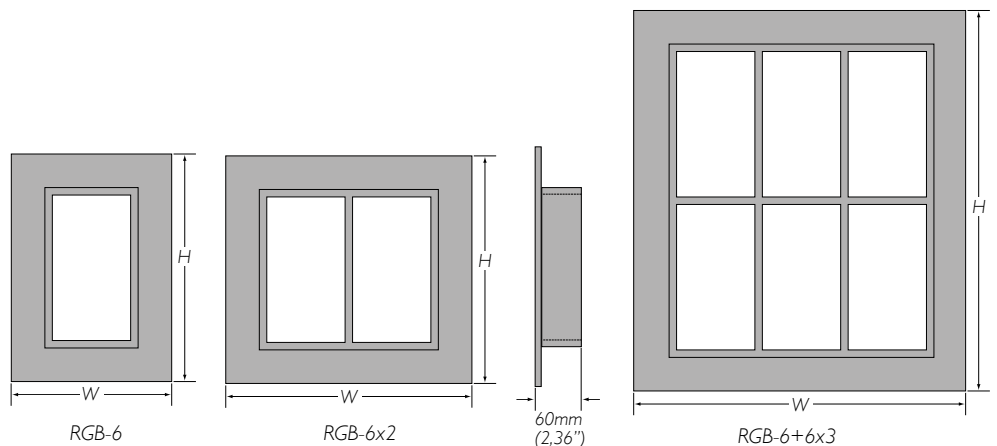

# RGB

## WEIGHT CHART

Standard frames in four different sizes: 2, 4, 6 and 8 which mark different heights. All have the same width. See below.

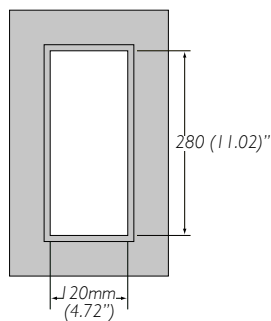
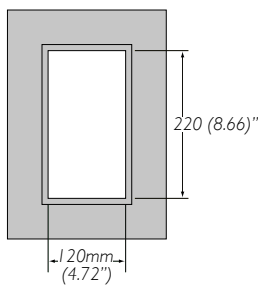
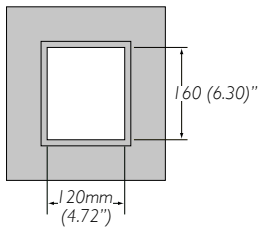
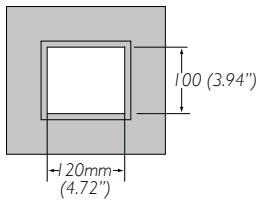

MATERIAL	FRAME SIZE	Weight in kilograms						Weight in pounds						
		W (width) Combination frames												
		x 1	x 2	x 3	x 4	x 5	x 6	x 1	x 2	x 3	x 4	x 5	x 6	
STEEL	RGB/RGG-2	3.1	5.0	6.9	8.8	10.7	12.6	6.8	11.0	15.2	19.4	23.5	27.7	
	RGB/RGG-4	3.8	5.9	8.1	10.2	12.4	14.6	8.3	13.0	17.8	22.4	27.5	32.1	
	RGB/RGG-6	4.4	6.8	9.2	11.5	13.8	16.3	9.7	14.9	20.2	25.3	30.4	35.9	
	RGB/RGG-8	5.0	7.7	10.4	13.1	15.8	18.5	11.0	16.9	22.9	28.8	34.8	40.7	
	SS EN 10025- S235JRG2	RGB/RGG-2+2	5.0	7.9	10.9	13.9	16.8	19.8	11.0	17.4	24.0	30.6	37.0	43.6
		RGB/RGG-2+4	5.6	9.0	12.4	15.7	19.1	22.4	12.3	19.8	27.3	34.6	42.1	49.3
	DIN RST 37-2	RGB/RGG-2+6	6.2	9.9	13.6	17.3	21.0	24.7	13.6	21.8	29.9	38.1	46.2	54.4
		RGB/RGG-2+8	6.9	11.0	15.1	19.2	23.3	27.4	15.2	24.2	33.2	42.3	51.3	60.4
	BS 4360 gr. 40	RGB/RGG-4+4	6.2	9.9	13.6	17.3	21.0	24.7	13.6	21.8	29.9	38.1	46.2	54.4
		RGB/RGG-4+6	6.9	11.0	15.1	19.2	23.3	27.4	15.2	24.2	33.2	42.3	51.3	60.4
	NS 17100	RGB/RGG-4+8	7.4	11.8	16.2	20.6	25.0	29.4	16.3	26.0	35.7	45.4	55.1	64.8
		RGB/RGG-6+6	7.4	11.8	16.2	20.6	25.0	29.4	16.3	26.0	35.7	45.4	55.1	64.8
	RGB/RGG-6+8	8.1	13.0	17.9	22.7	27.6	32.4	17.8	28.6	39.4	50.0	60.8	71.4	
	RGB/RGG-8+8	8.9	14.2	19.5	24.9	30.2	35.5	19.6	31.3	42.9	54.8	66.5	78.2	
STAINLESS STEEL	RGB/RGG-2	3.2	5.1	7.1	9.0	11.0	12.9	7.0	11.2	15.6	19.8	24.2	28.4	
	RGB/RGG-4	3.9	6.1	8.3	10.5	12.7	14.9	8.5	13.4	18.2	23.1	27.9	32.8	
	RGB/RGG-6	4.5	6.9	9.4	11.8	14.2	16.7	9.9	15.2	20.7	26.0	31.3	36.8	
	RGB/RGG-8	5.2	7.9	10.7	13.5	16.2	19.0	11.4	17.4	23.5	29.7	35.7	41.8	
	DIN 1,4404	RGB/RGG-2+2	5.1	8.1	11.2	14.2	17.2	20.3	11.2	17.8	24.5	31.3	37.9	44.7
		RGB/RGG-2+4	5.8	9.2	12.7	16.1	19.6	23.0	12.7	20.2	27.9	35.4	43.2	50.7
	ASTM/316 L	RGB/RGG-2+6	6.3	10.1	13.9	17.8	21.6	25.4	13.8	22.2	30.6	39.2	47.6	55.9
		RGB/RGG-2+8	7.1	11.3	15.5	19.7	23.9	28.1	15.6	24.9	34.1	42.4	52.6	61.9
	AlSi 316 L	RGB/RGG-4+4	6.3	10.1	13.9	17.8	21.6	25.4	13.8	22.2	30.6	39.2	47.6	55.9
		RGB/RGG-4+6	7.1	11.3	15.5	19.7	23.9	28.1	15.6	24.9	34.1	43.4	52.6	61.9
	BS 970 gr. 316	RGB/RGG-4+8	7.6	12.1	16.6	21.1	25.6	30.1	16.7	26.6	36.5	46.5	56.4	66.3
		RGB/RGG-6+6	7.6	12.1	16.6	21.1	25.6	30.1	16.7	26.6	36.5	46.5	56.4	66.3
S11	RGB/RGG-6+8	8.4	13.3	18.3	23.3	28.3	33.3	18.5	29.3	40.3	51.3	62.3	73.4	
	RGB/RGG-8+8	9.1	14.6	20.0	25.5	31.0	36.4	20.0	32.1	44.0	56.2	68.3	80.2	
ALUMINIUM	RGB/RGG-2	1.1	1.8	2.5	3.1	3.8	4.4	2.4	3.9	5.5	6.8	8.3	9.7	
	RGB/RGG-4	1.4	2.1	2.9	3.6	4.4	5.1	3.0	4.6	6.3	7.9	9.7	11.2	
	RGB/RGG-6	1.6	2.4	3.2	4.1	4.9	5.7	3.5	5.2	7.0	9.0	10.8	12.5	
	RGB/RGG-8	1.8	2.7	3.7	4.6	5.6	6.5	3.9	5.9	8.1	10.1	12.3	14.3	
	EN AW6082	RGB/RGG-2+2	1.8	2.8	3.9	4.9	5.9	7.0	3.9	6.1	8.5	10.8	13.0	15.4
		RGB/RGG-2+4	2.0	3.2	4.4	5.5	6.7	7.9	4.4	7.0	9.7	12.1	14.7	17.4
	DIN ALMG SI 1	RGB/RGG-2+6	2.2	3.5	4.8	6.1	7.4	8.7	4.8	7.7	10.5	13.4	16.3	19.1
		RGB/RGG-2+8	2.4	3.9	5.3	6.7	8.2	9.6	5.2	8.5	11.6	14.7	18.0	21.1
	A 6082	RGB/RGG-4+4	2.2	3.5	4.8	6.1	7.4	8.7	4.8	7.7	10.5	13.4	16.3	19.1
		RGB/RGG-4+6	2.4	3.9	5.3	6.7	8.2	9.6	5.2	8.5	11.6	14.7	18.0	21.1
	BS H30/6082 TF	RGB/RGG-4+8	2.6	4.2	5.7	7.2	8.8	10.3	5.7	9.2	12.5	15.8	19.4	22.7
		RGB/RGG-6+6	2.6	4.2	5.7	7.2	8.8	10.3	5.7	9.2	12.5	15.8	19.4	22.7
NS 17305	RGB/RGG-6+8	2.9	4.6	6.3	8.0	9.7	11.4	6.3	10.1	13.8	17.6	21.3	25.1	
	RGB/RGG-8+8	3.2	5.0	6.9	8.7		12.5	7.0	11.0	15.2	19.1	23.3	27.5	

# Multiple Frames



RGS frame



RGB frame

## HORIZONTAL MULTIPLE FRAMES

Horizontal multiple frames are described by listing the frame type and size x the desired number of horizontal openings.

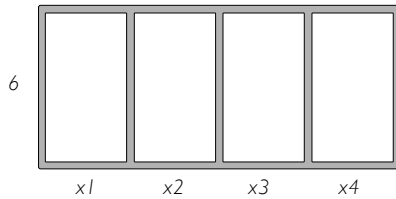

RGS 6x4

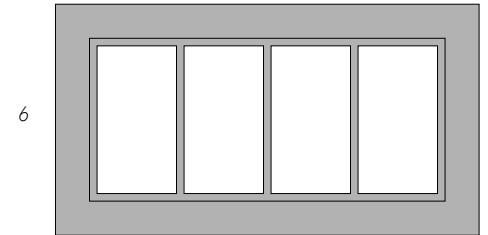

RGB 6x4

## VERTICAL MULTIPLE FRAMES

Vertical multiple frames are described by listing the bottom frame type and size + the next frame type and size.

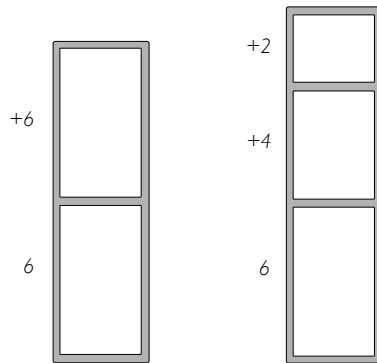

RGS 6+6

RGS 6+4+2

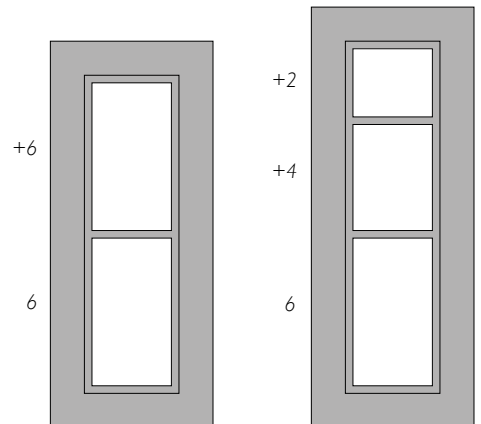

RGB 6+6

RGB 6+4+2

## VERTICAL AND HORIZONTAL MULTIPLE FRAMES

List the entire vertical frames x the desired number of horizontal repetitions.

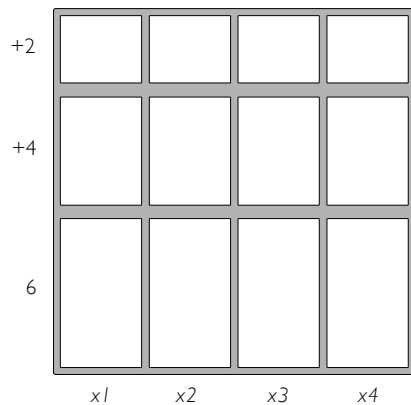

Designation starting at bottom:

RGS 6+4+2x4

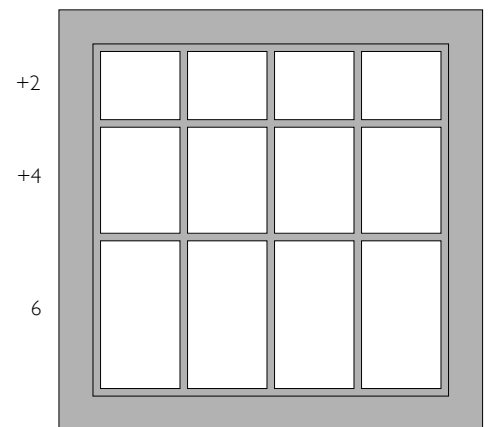

RGB 6+4+2x4

NOTE: All multiple frame designations must be preceded by the frame type.

# E-RGP-round holes

The E-RGP is a round Lycron frame for assembly in pipes. A copper sheet forms the contact between insert block and pipe housing. The seal is available in 6 sizes with the designations E-RGP -50, -70, -100, -125, -150 and -200.



E-RGP is a circular seal for holes or pipes.

Weight in kilograms (pounds)			
<b>E-RGP 50</b>	<b>E-RGP 70</b>	<b>E-RGP 100</b>	
0,25 kg (55 lb)	0,4 kg (0.88 lb)	0,7 kg (1.54 lb)	
<b>E-RGP 125</b>	<b>E-RGP 150</b>	<b>E-RGP 200</b>	<b>E-RGP 300</b>
1,0 kg (2.20 lb)	1,8 kg (3.96 lb)	3,0 kg (6.61 lb)	7,5kg (16.5lb)

## Sleeves



The round sleeve is used to house the E-RGP seal. The sleeve is available in six different sizes. There are several types to choose from, with and without flanges, for welding and for bolting, plus an open version. For more information, contact MCT Brattberg.

FRAME SIZE	Dimensions in mm (inches)	
	PACKING AREA	DEPTH AND DIAMETER
RGP 50 (2")		
RGP 70 (3")		
RGP 100 (4")		
RGP 125 (5")		
RGP 150 (6")		
RGP 200 (8")		
RGP 300 (11.8")		

# Components

## E-PTG PRESSWEDGE

The PTG Presswedge is available in two versions, Allen and Hex. Both can be placed anywhere in the frame. Made of Lycron, stainless steel fittings.

The copper sheet forms a contact between the frame and the stayplate. Must always be be installed in combination with a stayplate.

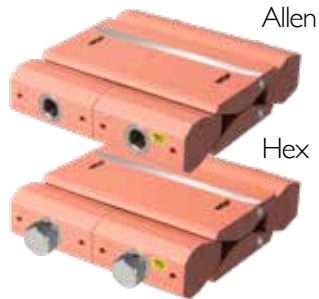

## E-STG ENDPACKING

Installed between Compression Plate and the top of the frame, completing the seal. Made of Lycron with galvanized or stainless steel fittings. The copper sheet forms a contact between the frame and compression plate.



## TWEEZERS

Can be used to fit E-insert or spare blocks. Grips the metal sheet and assists installation of the last row of blocks.



## LUBRICANT

30g /25ml (0.07 pound / 0.85 oz)

For easier installation and must be used with pressure-tight installation,



## STAYPLATE

To be placed between each row of blocks. Stayplates simplify installation, increase stability and anchor blocks within the frame. Plates come in stainless steel.



## COMPRESSION PLATE

Usually assembled above top row of blocks. The plate bolt is tightened to compress blocks around cables, while providing room for E-STG endpacking. Material: Cast iron hot galvanized.



## END PACKER PULLER

For re-entry into system.



## THE EMC MARKING TEMPLATE

Ensures that the cables are placed with the exposed screen of the cable over the metal sheet in Insert Blocks.



Weight in Kg/LB			
E-STG	E-PTG	COMPRESSION PLATE	STAYPLATE
0.6 KG/1.32 LB	0.82 KG/1.80 LB	0.63 KG/1.38 LB	0.13KG/0.28 LB



# Packing Space

RGS maximum number of cables and pipes							
Frame sizes	Block sizes						
	15	20	30	40	60	90	120
RGS 2	32	18	8	3	2	-	-
RGS 4	64	36	16	9	4	1	1
RGS 6	96	54	24	12	6	2	1
RGS 8	128	72	32	18	8	2	2

RGP maximum number of cables and pipes							
Frame sizes	Block sizes						
	15	20	30	40	60	90	120
RGP 50 (2")	4	1	1	-	-	-	-
RGP 70 RGP (3")	4	4	1	1	-	-	-
RGP 100 RGP (4")	16	9	4	1	1	-	-
RGP 125 RGP (5")	25	16	4	1	1	-	-
RGP 150 RGP (6")	36	16	9	4	1	1	-
RGP 200 RGP (8")	64	36	16	9	4	1	1

A couple of examples of pack plans (RG Plan) are shown here. RGS to the left and RGP below. The largest cables are placed at the bottom.

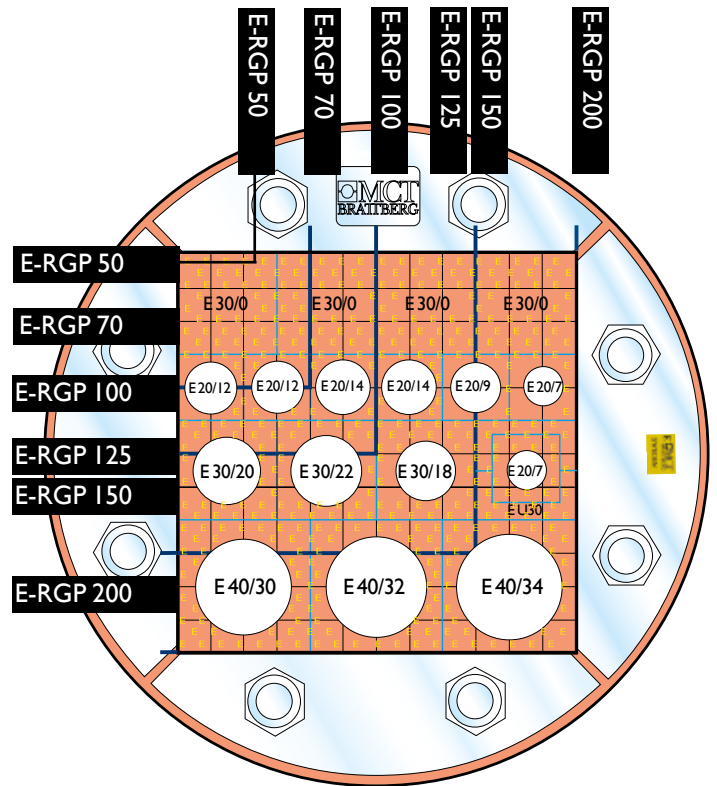
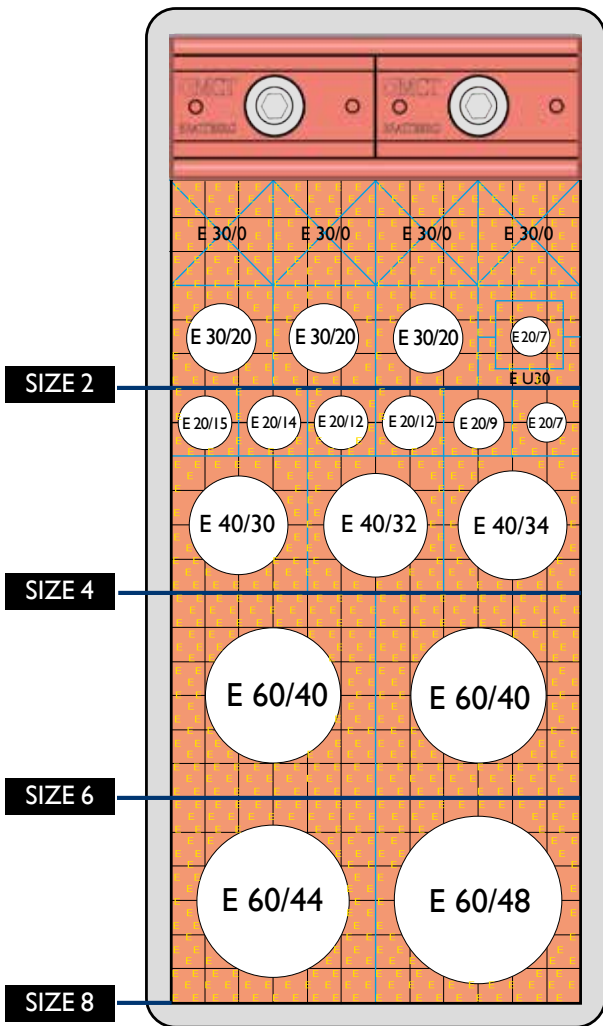

Combination frame width compared with width of cable tray					
Cable type	Frame size	Cable tray width in mm /inches			
		150 /5.91	200/7.87	300/11.81	400/15.75
Signal	6	6x2	6x3	6x4	6x5
Power	4	4x2	4x3	4x4	4x5
Combination	6	6x2	6x3	6x4	6x5

## Choosing the correct

# E-Blocks

Our standard range of E-Blocks accommodates cables between 4 and 54 mm (0.2" and 1.3") in diameter. It is important that the E-Block is the right size, with respect to the cable, to ensure a proper seal.

Measure the cable diameters carefully and choose E-Blocks accordingly. With the sizing chart on next page you can choose the correct size of E-Blocks.

E-Blocks are referred to by their width (A) and hole diameter (B).

Thus an E-Block with a width of 15 mm (0.59") and a hole diameter of 4 mm (0.2") is referred to as 15/4. This designation is moulded into the E-Block.

The E-Block has an integral copper sheet as discharging and shielding protection between the cable and the system.

There are 2 different designs of copper sheets, one for outer cable diameters up to 10 mm (0.39") and one for outer cable diameters over 10 mm (0.39").

The design guarantees good contact without damaging the cable braid. E-Block modules are affixed with yellow "E" on one of the short ends.

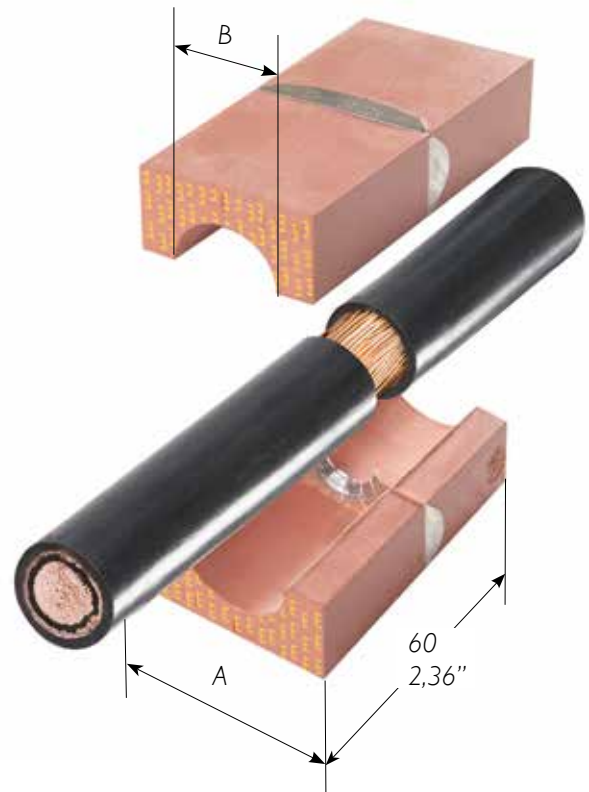

# E-Spare Blocks

Surplus room in each frame is filled out with solid E-Blocks. Called spares, they bear the designation A/0.

The copper sheet forms contact between surrounding blocks and the frame.

E-Blocks are referred to by their width (A), followed by the designation /0 (indicating solid).

Thus an E-Block with a width and height of 15 mm (0.59") is referred to as 15/0.

The length of E-Blocks is always 60 mm (2.36").

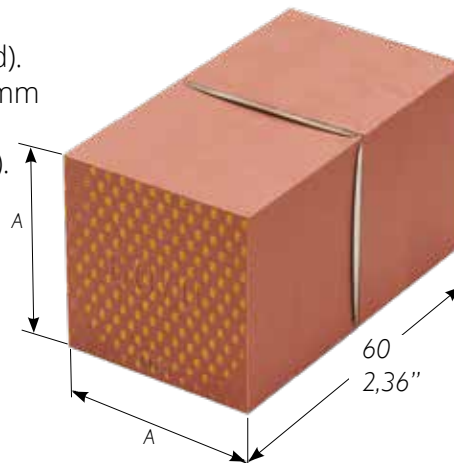

CABLE DIAM.	A (mm)				B	CABLE DIAM.	A (mm)			B	CABLE DIAM.	A (mm)		B
	15	20	30	40			40	60	90			90	120	
3.5-4.5	15/4	20/4			4	25.5-27.5	40/26			26	55.5-57.5	90/56		56
4.5-5.5	15/5	20/5			5	27.5-29.5	40/28			28	57.5-59.5	90/58		58
5.5-6.5	15/6	20/6			6	29.5-31.5	40/30			30	59.5-61.5	90/60		60
6.5-7.5	15/7	20/7			7	31.5-33.5	40/32	60/32		32	61.5-63.5	90/62		62
7.5-8.5	15/8	20/8			8	33.5-35.5	40/34	60/34		34	63.5-65.5	90/64		64
8.5-9.5	15/9	20/9			9	35.5-37.5		60/36		36	65.5-67.5	90/66		66
9.5-10.5		20/10			10	37.5-39.5		60/38		38	67.5-69.5	90/68		68
10.5-11.5		20/11			11	39.5-41.5		60/40		40	69.5-71.5	90/70		70
11.5-12.5		20/12	30/12		12	41.5-43.5		60/42		42	71.5-73.5	120/72	72	
12.5-13.5		20/13	30/13		13	43.5-45.5		60/44		44	73.5-75.5	120/74	74	
13.5-14.5		20/14	30/14		14	45.5-47.5		60/46		46	75.5-77.5	120/76	76	
14.5-15.5			30/15		15	47.5-49.5		60/48		48	77.5-79.5	120/78	78	
15.5-16.5			30/16		16	49.5-51.5		60/50	90/50	50	79.5-81.5	120/80	80	
16.5-17.5			30/17		17	51.5-53.5		60/52	90/52	52	81.5-83.5	120/82	82	
17.5-18.5			30/18		18	53.5-55.5		60/54	90/54	54	83.5-85.5	120/84	84	
18.5-19.5			30/19		19						85.5-87.5	120/86	86	
19.5-20.5			30/20		20						87.5-89.5	120/88	88	
20.5-21.5			30/21		21						89.5-91.5	120/90	90	
21.5-22.5			30/22	40/22	22						91.5-93.5	120/92	92	
22.5-23.5			30/23	40/22	23						93.5-95.5	120/94	94	
23.5-24.5			30/24	40/24	24						95.5-97.5	120/96	96	
23.5-25.5				40/24	24						97.5-99.5	120/98	98	
											99.5-101.5	120/100	100	

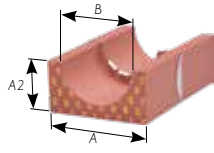

Blocks are referred to by their width (A) and hole diameter (B). Thus a module with a width of 15 mm and a hole diameter of 4 mm is referred to as 15/4.

CABLE DIAM.	A (inches)				B	CABLE DIAM.	A (inches)			B	CABLE DIAM.	A (inches)		B
	0.59	0.79	1.18	1.58			1.58	2.36	3.55			3.55	4.73	
0.14-0.18	15/4	20/4			0.16	1.00-1.10	40/26			1.02	2.18-2.26	90/56		2.21
0.18-0.22	15/5	20/5			0.20	1.10-1.16	40/28			1.10	2.26-2.34	90/58		2.29
0.22-0.26	15/6	20/6			0.24	1.16-1.24	40/30			1.18	2.34-2.42	90/60		2.36
0.26-0.30	15/7	20/7			0.28	1.24-1.32	40/32	60/32		1.26	2.42-2.50	90/62		2.44
0.30-0.33	15/8	20/8			0.31	1.32-1.40	40/34	60/34		1.34	2.50-2.58	90/64		2.52
0.33-0.37	15/9	20/9			0.35	1.40-1.48		60/36		1.42	2.58-2.66	90/66		2.60
0.37-0.41		20/10			0.39	1.48-1.55		60/38		1.50	2.66-2.74	90/68		2.68
0.41-0.45		20/11			0.43	1.55-1.63		60/40		1.58	2.74-2.81	90/70		2.76
0.45-0.49		20/12	30/12		0.47	1.63-1.71		60/42		1.65	2.81-2.89	120/72	2.84	
0.49-0.53		20/13	30/13		0.51	1.71-1.79		60/44		1.73	2.89-2.97	120/74	2.92	
0.53-0.57		20/14	30/14		0.55	1.79-1.87		60/46		1.81	2.97-3.05	120/76	2.99	
0.57-0.61			30/15		0.59	1.87-1.95		60/48		1.89	3.05-3.13	120/78	3.07	
0.61-0.65			30/16		0.63	1.95-2.03		60/50	90/50	1.97	3.13-3.21	120/80	3.15	
0.65-0.69			30/17		0.67	2.03-2.11		60/52	90/52	2.05	3.21-3.29	120/82	3.23	
0.69-0.73			30/18		0.71	2.11-2.18		60/54	90/54	2.13	3.29-3.36	120/84	3.31	
0.73-0.77			30/19		0.75						3.36-3.44	120/86	3.39	
0.77-0.81			30/20		0.79						3.44-3.52	120/88	3.47	
0.81-0.85			30/21		0.83						3.52-3.60	120/90	3.55	
0.85-0.89			30/22	40/22	0.87						3.60-3.68	120/92	3.62	
0.89-0.93			30/23	40/22	0.91						3.68-3.76	120/94	3.70	
0.93-1.00			30/24	40/24	0.95						3.76-3.84	120/96	3.78	
				40/24							3.84-3.92	120/98	3.86	
											3.92-3.99	120/100	3.94	

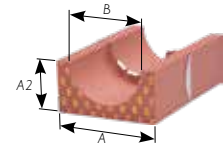

Blocks are referred to by their width (A) and hole diameter (B). Thus a module with a width of 0.59" and a hole diameter of 0.16" is referred to as 15/4.

Weight in grams per half							
BLOCK	W	BLOCK	W	BLOCK	W	BLOCK	W
24 x 5/0	58	20/11	13	40/30	42	90/62	239
12 x 10/0	113	20/12	13	40/32	37	90/64	229
15/0	20	20/13	12	40/34	32	90/66	220
20/0	38	20/14	11	60/32	131	90/68	211
30/0	84	30/12	36	60/34	127	90/70	204
40/0	150	30/13	36	60/36	122	120/72	494
60/0	338	30/14	35	60/38	116	120/74	485
90x30/0	279	30/15	34	60/40	110	120/76	472
15/4	10	30/16	33	60/42	104	120/78	462
15/5	10	30/17	31	60/44	98	120/80	448
15/6	10	30/18	30	60/46	91	120/82	437
15/7	10	30/19	28	60/48	84	120/84	425
15/8	9	30/20	27	60/50	77	120/86	415
15/9	8	30/21	25	60/52	59	120/88	403
20/4	18	30/22	24	60/54	61	120/90	385
20/5	18	30/23	22	90/50	287	120/92	368
20/6	17	30/24	21	90/52	279	120/94	360
20/7	17	40/22	57	90/54	273	120/96	351
20/8	16	40/24	54	90/56	262	120/98	332
20/9	15	40/26	50	90/58	255	120/100	313
20/10	14	40/28	47	90/60	243	120/108	243

Weight in oz per half							
BLOCK	W	BLOCK	W	BLOCK	W	BLOCK	W
24 x 5/0	2.0	20/11	0.5	40/30	1.5	90/62	8.4
12 x 10/0	4.0	20/12	0.5	40/32	1.3	90/64	8.1
15/0	0.7	20/13	0.4	40/34	1.1	90/66	7.7
20/0	1.3	20/14	0.4	60/32	4.7	90/68	7.4
30/0	3.0	30/12	1.3	60/34	4.5	90/70	7.2
40/0	5.3	30/13	1.3	60/36	4.3	120/72	17.4
60/0	11.9	30/14	1.2	60/38	4.1	120/74	17.1
90x30/0	9.8	30/15	1.2	60/40	3.9	120/76	16.6
15/4	0.4	30/16	1.2	60/42	3.7	120/78	16.3
15/5	0.4	30/17	1.1	60/44	3.5	120/80	15.8
15/6	0.4	30/18	1.0	60/46	3.2	120/82	15.4
15/7	0.4	30/19	1.0	60/48	3.0	120/84	15.0
15/8	0.3	30/20	1.0	60/50	2.7	120/86	14.6
15/9	0.3	30/21	0.9	60/52	2.4	120/88	14.2
20/4	0.6	30/22	0.8	60/54	2.2	120/90	13.6
20/5	0.6	30/23	0.8	90/50	10.1	120/92	13.0
20/6	0.6	30/24	0.7	90/52	9.8	120/94	12.7
20/7	0.6	40/22	2.0	90/54	9.6	120/96	12.3
20/8	0.6	40/24	1.9	90/56	9.2	120/98	11.7
20/9	0.5	40/26	1.8	90/58	9.0	120/100	11.0
20/10	0.5	40/28	1.7	90/60	8.6	120/108	8.6

# E-AddBlock

## Eleven blocks and 66 dimensions

The E-AddBlocks basic dimension is given at bottom slot center, and that's the maximum cable dimension the block is designed for.

Dimensions are also clearly marked on the four insert sheets. Simply select, tear off and insert.

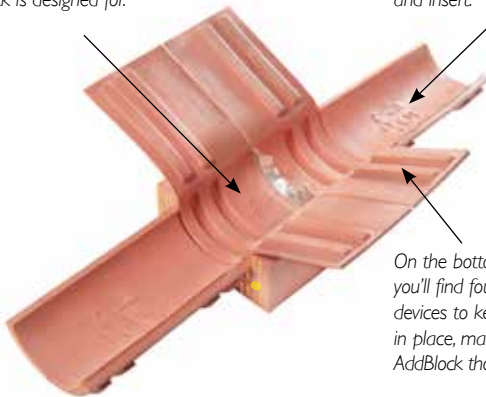

On the bottom of each sheet you'll find four locking devices to keep the insert in place, making each AddBlock thoroughly secure.



There are eleven different sizes of E-AddBlock. By tearing off the wing-like inserts, which are of varying thickness, and inserting them in the main block it is possible to accommodate 66 different cable and pipe dimensions, from 3.5 mm (0.14") to 69.5 mm (2.74"). The inserts are fitted with a locating ridge that fits exactly into furrows in the main block. These stop the block from "telescoping".

A seal using E-AddBlocks is as secure and tight as one using standard blocks. Both types can be combined in a transit, which makes the MCT Brattberg seal system very flexible. E-AddBlocks are all the same length as standard blocks, 60 mm (2.36"). The width of standard blocks (A measurement, see table) are 20, 30, 40, 60 or 90 mm (0.79", 1.18", 1.57", 2.36" or 3.5"). E-Addblock modules are affixed with a small yellow dot on one of the short ends.

ADDBLOCK DIMENSION	CABLE OR PIPE DIMENSION (mm)	WEIGHT PER HALF (G)	CABLE OR PIPE DIMENSION (inches)	WEIGHT PER HALF (oz)
20/4 - 8	3,5 - 8,5	23	0.14 - 0.33	0.8
20/9 - 13	8,5 - 13,5	23	0.33 - 0.53	0.8
30/14	13,5 - 18,5	45	0.53 - 0.72	1.6
30/19	18,5 - 23,5	43	0.72 - 0.93	1.5
40/24	23,5 - 28,5	71	0.93 - 1.12	2.5
40/29	28,5 - 33,5	62	1.12 - 1.32	2.2
60/34	33,5 - 38,5	150	1.32 - 1.52	5.3
60/39	38,5 - 43,5	136	1.52 - 1.71	4.8
60/44	43,5 - 49,5	128	1.71 - 1.95	4.5
90/50	49,5 - 59,5	348	1.95 - 2.34	12.3
90/60	59,5 - 69,5	318	2.34 - 2.74	11.2

1. The E-AddBlock comes complete with 4 inserts to give 5 different block sizes.

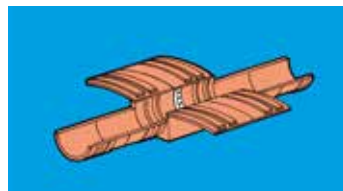

3. Select the insert with the required diameter and tear along the perforations.



2. Remove all inserts.



4. Attach the two inserts into the locating ridges.



**E-Series**

# Grounding and Bonding

**For Series RGS, RGB, RGG, and E-RGP**

These products are primarily intended for grounding and bonding of communication, instrument, power, braid or wire armored cables and copper pipes.

It is sufficient to use standard STG-Endpacking and Composite Compression Plate or PTG Presswedge instead of the E- version of these components.

Standards:

- CSA Std. C22.2 No. 4.1
- CSA Std. C22.2 No. 18.3
- CSA Std. C22.2 No. 182.3
- UL Std. 467
- UL Std. 514B
- UL Std. 1977



- Grounding and Bonding Equipment
- Conduit, Tubing and Cable Fittings
- Special use attachment plugs, receptacles and connectors (as a guide)
- Grounding and Bonding Equipment
- Conduit, Tubing and Cable Fittings
- Component Connectors for use in Data, Signal, Control and Power applications



E- Block size	Copper sheet cross section mm <sup>2</sup>	Cable/pipe OD (mm)	Max conductor/braid size (cable/pipe)		Copper sheet cross section (inches <sup>2</sup> )	Cable/pipe OD (inch")	Max conductor/braid size (cable/pipe)	
			AWG	Area mm <sup>2</sup>			AWG	Area (inches <sup>2</sup> )
20	4-8	3.5-9.5	11	4	0.16 - 0.32	0.14 - 0.37	11	0.08
20	6-12	9.5-16.5	9	4	0.24 - 0.52	0.37 - 0.65	9	0.12
30	13-21	11.5-24.5	6	13	0.52 - 0.86	0.45 - 0.96	6	0.52
40	21-31	21.5-35.5	4	21	0.82 - 1.26	0.85 - 1.40	4	0.41
60	42-45	31.5-55.5	1	42	1.66 - 1.96	1.24 - 2.19	1	8.83
90	50-65	49.5-71.5	1	42	1.95 - 2.56	1.95 - 2.81	1	8.83
120	75-94	71.5-101.5	1	42	2.96 - 3.70	2.81 - 4.00	1	8.83



E- Block size	Copper sheet cross section mm <sup>2</sup>	Cable/pipe OD (mm)	Max conductor/braid size (cable/pipe)		Copper sheet cross section (inches <sup>2</sup> )	Cable/pipe OD (mm)	Max conductor/braid size (cable/pipe)	
			AWG	Area mm <sup>2</sup>			AWG	Area (inches <sup>2</sup> )
20	4-8	3.5-8.5	11	4	0.16- 0.32	0.14 - 0.33	11	0.08
20	6-13	8.5-13.5	9	4	0.24 - 0.48	0.33 - 0.53	9	0.12
30	13-22	13.5-23.5	6	13	0.52 - 0.82	0.53 - 0.93	6	0.26
40	21-32	23.5-33.5	4	21	0.82 - 1.22	0.93 - 1.32	4	0.41
60	42-50	33.5-49.5	1	42	1.66 - 1.78	1.32 - 1.95	1	0.83
90	50-65	49.5-69.5	1	42	2.12 - 2.32	1.95 - 2.74	1	0.83



E-Spare Block size
24x5/0
12x10/0
15x0
20x0
30x0
40x0
60x0

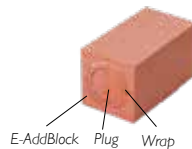

E-ADDBLOCK	PLUG	WRAP
E-20/4 - 8	P20/8	
E-20/9 - 13	P20/8 +	W20/8-13
E-30/14 - 18	P30/18	
E-30/19 - 23	P30/18 +	W30/18-23
E-40/24 - 28	P40-28	
E-40/29 - 33	P40-28 +	W40/28-33
E-60/34 - 38	P60/38	
E-60/39 - 43	P60/38 +	W60/38-43
E-60/44 - 48	P60/38 +	W60/38-43 and W60/43-48

Pluggs and Wraps are only for use in Grounding and Bonding applications, not EMC

# Packing Plan

The correct frame size can be determined by using this plan. The numbers 2, 4, 6 and 8 in the margin represent the packing space available in frames size 2, 4, 6 and 8 respectively. It is not necessary to show stayplates and compression components as the required space has already been allowed for. RG-Packing Plans will be supplied free of charge upon request.

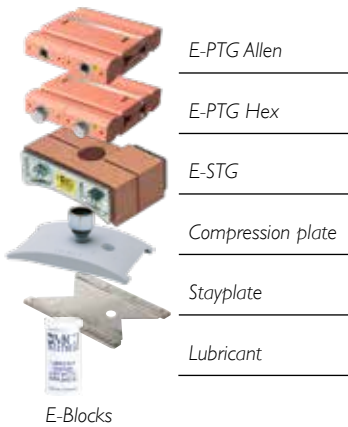

RGP 50 (2")

RGP 70 (3")

RGP 100 (5")

RGP 125 (6")

RGP 150 (7")

RGP 200 (8")

SIZE 2

SIZE 4

SIZE 6

SIZE 8

10x10 mm  
(0.39"x0.39")

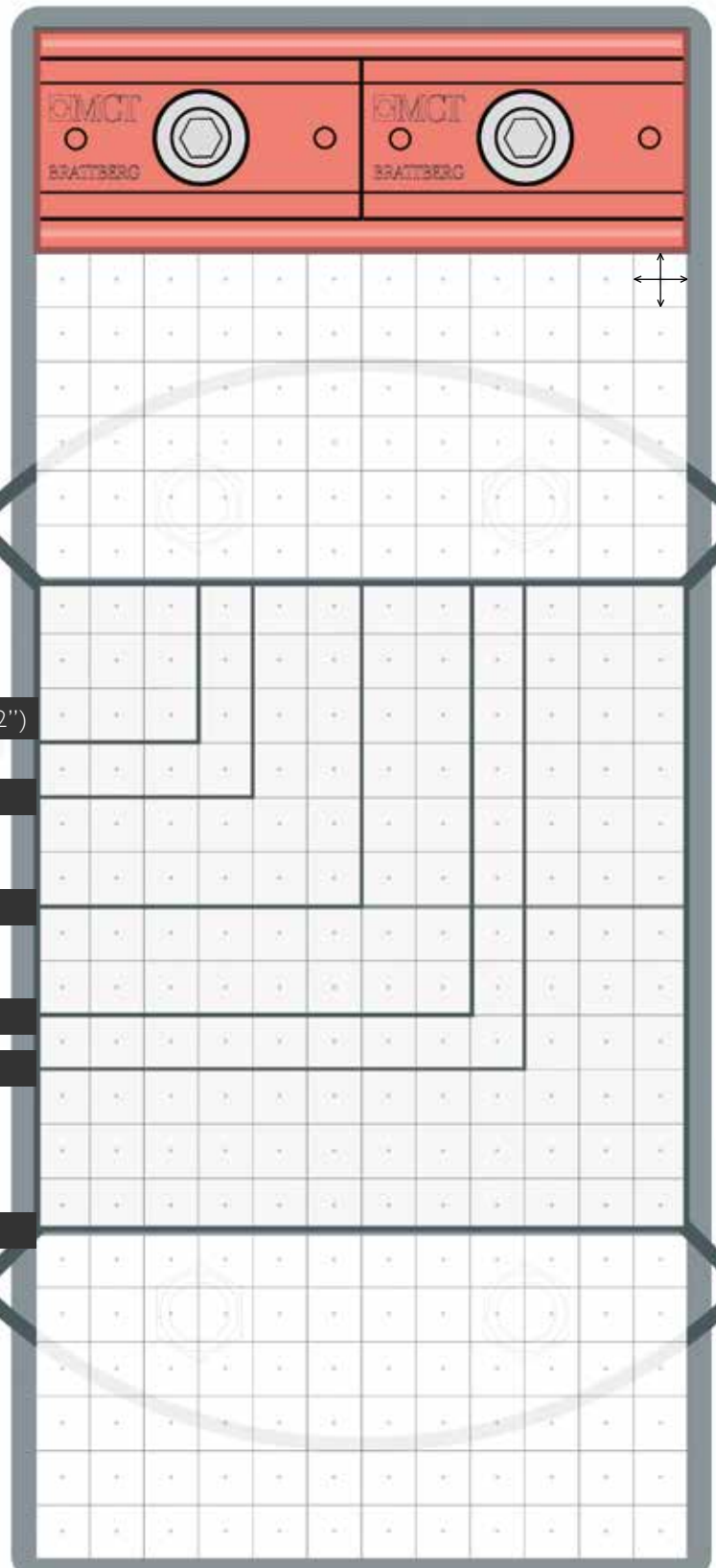

# E-RGP

E-Blocks

---

---

---

---

---

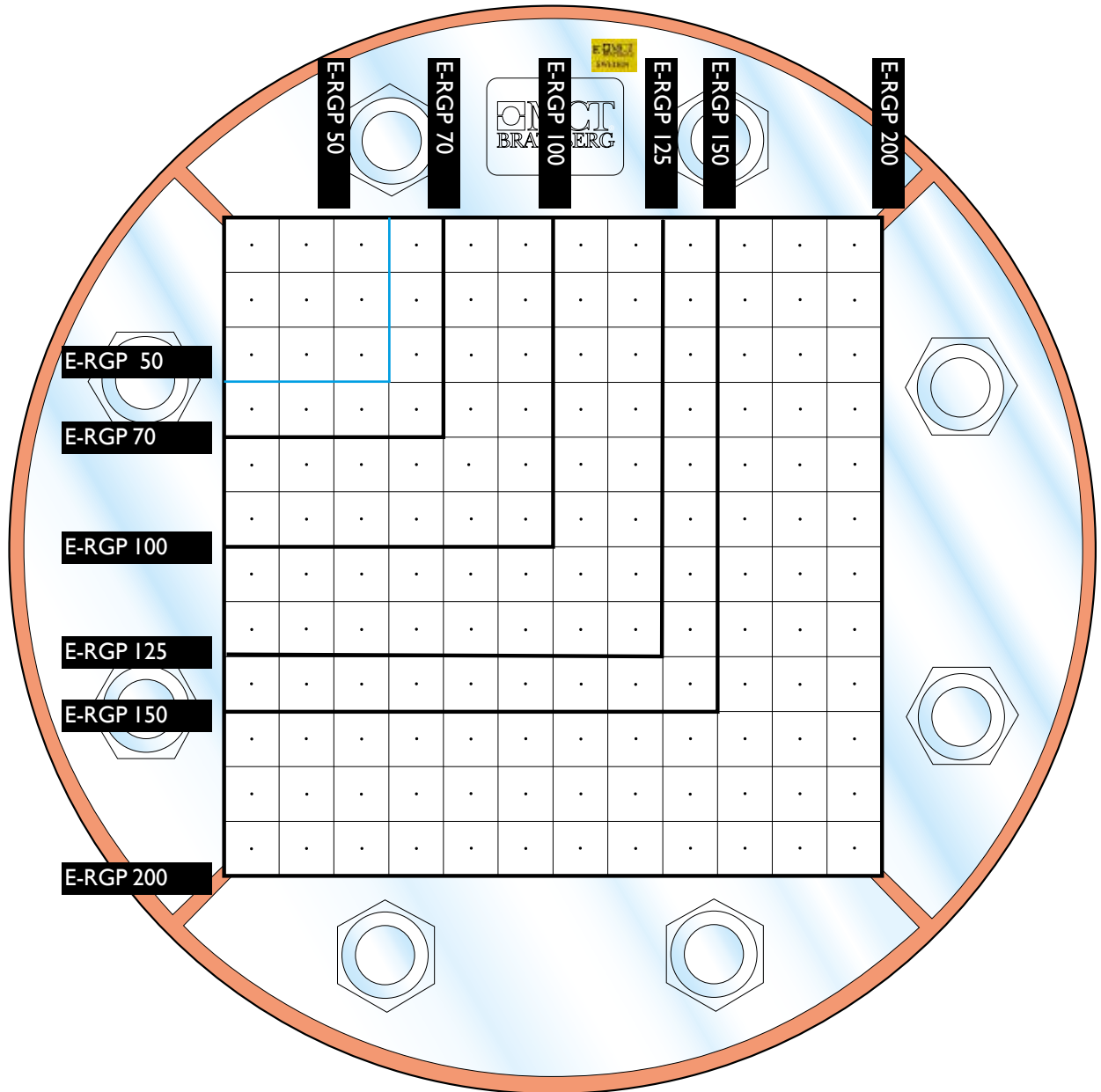





# IECEX / ATEX



Putting  
safety first

# Products for a safer and more secure work environment



MCT Brattberg's concept for modular cable and pipe transits has been market leading for more than half a century. Our flexible system seals cables and pipes through the framework of the building without compromising safety. MCT Brattberg cable and pipe transits are tested and approved by the leading certification authorities and laboratories worldwide.

According to EU regulations and IECEx standards all working environments where explosive materials are present the ATEX Directive must be applied. This applies to areas with fuel production and storage, handling of chemicals and the build up of hazardous dust. MCT Brattberg has developed and tested an Ex-approved range of cable and pipe transits to protect adjacent locations in such areas.



# Where valuable assets are at risk

MCT Brattberg's concept for modular cable and pipe transits has been market leading for more than half a century. Our flexible system seals cables and pipes through the framework of the building without compromising safety. MCT Brattberg cable and pipe transits are tested and approved by the leading certification authorities and laboratories worldwide.

According to EU regulations and IECEx standards all working environments where explosive materials are present the ATEX Directive must be applied. This

applies to areas with fuel production and storage, handling of chemicals and the build up of hazardous dust. MCT Brattberg has developed and tested an Ex-approved range of cable and pipe transits to protect adjacent locations in such areas.

In high-risk environments, such as explosive hazardous areas, "Putting Safety First" is our number one priority. This is the reason why MCT Brattberg's products are installed globally.





## Tested and approved

When it comes to safety we lean on our long experience and independent tests.

In the most hazardous environments around the world, people and companies can rely on our cable and pipe transits. It is a tough job where valuable assets are at risk. We are proud to say that our transits have been tested against explosion, fire, water, gas, chemicals, vibrations and corrosion, met the maximum requirements and thus been certified by the approval authority.

MCT Brattberg products are approved by DNV-GL and meet the Quality and Environmental standard requirements of ISO 9001, 14001 and OHSAS 18001, we also conform to the ATEX Directive 2014/34/EC and the IECEx requirements.

We follow in engineer Brattberg footsteps when keeping our system flexible and safe. The system is based on standard units of Lycron through which cables and pipes are installed. Our products are made of the same high quality. To avoid any mix-up the Ex blocks are marked in both ends.

The system can adapt to any application and is easy to install. Safety lies in the simplicity. The system is intuitive, easy to understand and modify, which reduces the risk of installation error.

## System Flexibility

An explosion-proof transit is a matter of the whole system. There must not be any weak points. All modules complement and strengthen each other, from the smallest detail to the larger framework. Each component is constructed to sustain the impact of an explosion. Regardless different cable and pipe diameters an MCT Brattberg transit meets the demands for offshore and onshore. The frames are cut, welded, grinded, painted and stamped with logo and date.

The Lycron in the inserts is a synthetic halogen free polymer developed especially to withstand fire, explosions, temperature variation, ageing, vibration, radiation and pests. The inserts are injection moulded for accuracy. The dimensions have become the industry standard and have proved sustainable over time.

# IECEX & ATEX

## Some important notes

### **User environment**

IECEX & ATEX concerns all products to be used in places where explosive atmospheres may arise. Places where there can occur mixtures of air and flammable materials such as gases, vapours, mists and dusts.

### **Products IECEX & ATEX**

Ex does not only concern electrical equipment, but all equipment and protection system for use in potentially explosive atmospheres. In all premises within the worlds, where there is explosion risk, the equipment and protective systems must carry an Ex or ATEX Certificate.

IECEX stands for the certification by the International Electrotechnical Commission for Explosive Atmospheres. To be IECEX certified, all products must go through a monitored process by the International Electrotechnical Commission to ensure that they meet the minimum safety requirements. This process will determine if the products can be used in hazardous or potentially explosive locations.

### **Scope**

IECEX & ATEX conformity of products is compulsory. It also covers explosive dust/air mixtures as well as gases.

### **Classification of equipment**

The IECEX & ATEX contains classification into groups and categories which are defined by the marking on the equipment.

### **Area Classification**

Process plants are divided into Zones (European and IEC method) or Divisions (North American method) according to the likelihood of a potentially explosive atmosphere being present.

An area in which an explosive mixture is continuously present or present for long periods has the following

#### **Classification:**

Gases: Zone 0 Class I Division 1

Dusts: Zone 20 Class II Division 1

An area in which an explosive mixture is likely to occur in normal operation has the following Classification:

Gases: Zone 1 Class I Division 1

Dusts: Zone 21 Class II Division 1

An area in which an explosive mixture is not likely to occur in normal operation and if it occurs it will exist only for a short time has the following Classification:

Gases: Zone 2 Class I Division 2

Dusts: Zone 22 Class II Division 2



### **MCT Brattberg coding:**

II2GD Ex eb IIC Gb Ex tb IIIC Db T -60.c to +70.c

II = Surface and mining

2 = Zone 1/21 (1=Gas 21=Dust)

GD = Gas & Dust

Ex eb = Increased safety, b=zone 1,2

IIC = All gases approved

Gb = Gas zone 1 ( Zone 1 is also approved in zone 2. NOT ZONE 0 )

Ex tb = Dust enclosure 6 (IP)

IIIC = Conductive dust, also approved for A and B.  
A=Combustible flyings, B=none-conductive dust.

Db = Zone 21, dust also zone 22

-60.c to +70.c = Ex working temp min/max

Do not hesitate to contact us.

When it comes to safety, no questions are too small or large.

## Ex / ATEX

In high-risk environments, such as explosive hazardous areas, "Putting Safety First" is our number one priority. This is the reason why MCT Brattberg's products are installed globally.

Ex for high risk ATEX environments.



### RGS EX System

Multi cable & pipe transits for offshore applications, Ex hazardous marine and land-based structures.



### RGG & RGG Ex

Ex rated multi cable & pipe transits for buildings and land-based structures.

## RGS Ex System

The system consists of a frame, rubber blocks and a compression unit.

The frame is welded or bolted to a Ex hazardous marine structure and packed with rubber blocks suited for each cable and pipe dimension.

The compression unit is inserted to compress the rubber blocks against cables and pipes to establish a tight seal.

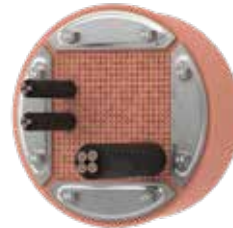

### RGP EX System

Circular Ex rated multi cable & pipe transits for assembly in sleeves.

## Benefits of MCT Brattberg Ex systems

- Ex rated transit for hazardous environments
- Assists cable management
- Seals the penetration against the passage of fire, water, gas, sound and environmental hazards
- Can be combined with special EMC modules and for Grounding and Bonding
- Unlike other brands our system can be dismantled and re-used
- Marked blocks for increased safety
- No adaptation of standard blocks needed

You will find more information about our Ex Products on our website [www.mctbrattberg.com](http://www.mctbrattberg.com)



# Installation Guides

You find instructions and guides on how to install our products on our website:

**[www.mctbrattberg.com](http://www.mctbrattberg.com)**



**We are  
putting  
safety  
first**



#### **Sweden**

Head office  
MCT Brattberg AB  
**Phone:** +46 - 455 37 52 00  
**Email:** info@mctbrattberg.se

**Address**  
SE-371 92 Karlskrona, Sweden

#### **Australia**

MCT Brattberg Australia Pty Ltd  
**Phone:** +61 (0)44 710 4422  
**Email:** info@mctbrattberg.com.au

**Address**  
Level 2, Margaret Graham Building  
Lot Fourteen  
1a Frome Road  
Adelaide, SA 5000, Australia

#### **United Kingdom**

MCT Brattberg Ltd  
**Phone:** +44 - 170 624 4890  
**E-mail:** info@mctbrattberg.co.uk

**Address**  
Commerce Street  
Carrs Industrial Estate Haslingden  
Lancashire BB4 5JT, England

#### **United Arab Emirates**

MCT Brattberg UAE  
Dubai, United Arab Emirates  
**Phone:** +971 50 277 2151  
**Email:** sony.jose@mctbrattberg.ae

#### **USA**

MCT Brattberg Inc  
**Phone:** +1 346 260 9124  
**Email:** sales@brattberginc.com

**Address**  
3332 Spring Stuebner Rd.  
Suite G, Spring, TX 77379, USA

#### **ASIA**

MCT Brattberg Asia Pte. Ltd.  
56 Kallang Pudding Road  
#09-08 HH@Kallang  
Singapore 349328  
**Email:** customerservice@mctbrattberg.com.sg

**Please visit our website for contact information to your closest MCT Brattberg representative:**

**[www.mctbrattberg.com](http://www.mctbrattberg.com)**